

The ANDOVER TOWNSMAN

Andover's Own Newspaper Since 1887

VOLUME 67 NUMBER 17

ANDOVER, MASSACHUSETTS, FEBRUARY 4, 1954

PRICE 5 CENTS



Members of the Andover committee in charge of the Salvation Army campaign for operating funds which is being held this month. Back row, from left to right: Raymond S. LaRosa, campaign chairman; David P. Cardinal, veterans' division; G. Homer Judge, industrial division; Alexander H. Rogers II, publicity; front row, Roy E. Hardy, honorary chairman; Lenore D. Macartney, treasurer; and Richard K. Gordon, general chairman. (Look Photo)

1954 Warrant Contains Requests For \$1,772,379

TOWN ACCOUNTANT'S ANNUAL REPORT

The annual report of the town accountant, George C. Napier, for the year 1953 shows the receipts, expenditures and other town finances as follows:

| | |
|--------------|-------------|
| Receipts | \$1,855,371 |
| Expenditures | 1,754,052 |
| Cash Balance | 611,430 |
| Income taxes | 117,514 |
| Corp. taxes | 138,431 |
| Free cash | 378,041 |

The 1954 town warrant contains requests for appropriations of approximately \$1,772,379. Departmental budgets total \$1,449,410 and the special articles \$322,969. In the latter is an item of \$60,000 free cash to reduce the 1954 tax rate and offset appropriations voted at the town meeting.

The total amount which voters at the town meeting will be asked to pass upon is the largest in the history of the town.

Not all of the articles call for appropriations. One is to see if the town will accept 12.21 acres of land on Red Spring road from Helen E. Hardy. This land is in back of the old sand and gravel pit and adjoins the Indian Ridge reservation. About three-quarters of a mile from the center of the town it might be developed into an area for recreation.

An article inserted by the selectmen calls for the payment of \$342 to Henry L. Hilton and \$333 to George L. Williams, under the Acts of 1947. Both men are members of

(Continued on Page 12)

Will Canvass Town For Heart Fund

On Valentine Sunday, Feb. 14, some 200 Andover men and women will call on their neighbors in the community; they will call as representatives of the Andover chapter of the Massachusetts Heart association, and they will be there because they care. They care that year after year in our own community, and throughout the country, one of every two deaths is caused by heart diseases. They care that this terrible toll has been cut and can be lowered more and more by research, education and community services.

(Continued on Page 14)

Salvation Army Campaign Opens

Andover's quota in the Salvation Army drive which will run all this month is \$4500, Atty. Richard K. Gordon, general chairman for Andover has announced.

Committees have been formed for the campaign and teams will be soliciting funds under various divisions intended to cover all sections of the town. Donations may be left at the R. J. Macartney store, 5

(Continued on Page Five)

Taxpayers Ass'n Favors Merger

The Andover Taxpayers' association under its president, George A. Grant of Dale st., is considering the town warrant and each director has been assigned certain articles to investigate.

The association two years ago suggested the merger of the tree department with the BPW. In this connection it now states:

(Continued on Page 14)

Political Advertisement

Stafford A. Lindsay
Candidate For
SELECTMAN and ASSESSOR
Active In Andover Affairs
For Over 25 Years
James R. Mosher
78 Haverhill St., Andover

FOR YOUR NEW CHEVROLET
See Your
Andover Representative:
Charles McKew
RES. ANDOVER 1306-M
OFF: LAW. 4166
BRONSON CHEVROLET CO.

THE
ANDOVER Steam Laundry INC.
ANDOVER TEL. 110
COMPLETE
LAUNDRY & DRY CLEANING
SERVICE
CONSISTENT QUALITY
Hewitt Bros., Proprietors

B.P.W. Tightens Regulations For Accepting New Streets

Planning Group Discusses Zoning

The lay committee to assist the planning board, formed last December after a public meeting sponsored by the League of Women Vo-

(Continued on Page Five)

The board of public works is tightening up the requirements for the acceptance of new streets as public ways.

These are brought up at this time and explained in connection with the present discussions regarding proposed planning and zoning measures that are expected to come up at town meeting.

In its statement the board says: In view of the increasing interest in the control and planning of land subdivided for residential use, the board of public works wishes to point out that it has certain requirements in this direction which should be considered as closely

(Continued on Page Four)

WALLPAPER COLE PAINT
46 MAIN ST. TEL. 1156

COUNSELORS

For boys' and girls' Summer Day Camp. Live at home; transportation furnished. Excellent salaries for right persons. Specialists and general counselors. Teachers and college age only. John Page, Dodge's Row, Wenham, Mass.

"Pop" Wilson Nears His 83rd. Birthday

Penry C. Wilson, better known as "Pop" to everyone who greets him daily at the Andover News company where he is manager and owner, will celebrate his 83rd birthday Feb. 10.

Mrs. Wilson, his wife with whom he celebrated their 62nd wedding anniversary last Aug. 19, was 90 years old yesterday.

(Continued on Page 16)



Today Your Pharmacist Drops a Word About...

SMALLPOX VACCINE 1798

EDWARD JENNER

The English physician, Edward Jenner, was born in Berkeley, Gloucestershire in 1749. He acquired his medical education through study with the famous anatomist, John Hunter.

Dr. Jenner's perfection of smallpox vaccine in 1798 enabled the medical profession to strike the fear of smallpox from the hearts of all people.

DALTON PHARMACY
TEL. 107

YOUR DOCTOR'S KNOWLEDGE IS THE KEY TO HEALTH BRING HIS PRESCRIPTION TO US

SERVICE AND REPAIRS
All Types and Makes of
OIL BURNERS

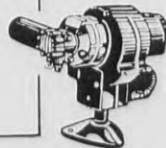

HEATING **HOWE** CORPORATION

LUPINE ROAD

TEL. 365

COMMERCIAL PRINTING

For Every Personal And Business Need

CALL 1943
THE TOWNSMAN

THANKS A MILLION

... you wonderful people of Andover who gave so generously to the MOTHERS' MARCH ON POLIO! Thanks to the Mothers, Workers, Police, Firemen and to ALL others who assisted. Thanks, too, to all who worked on the paper and rag drive Sunday.

C. Edward Buchan
J. Woodrow Crowley
Co-chairmen

ng Project area
ers are: Mrs.
Richard Call
e Levi.
area are: Miss
Miss Maures
the workers in
ardvale will be
ms.
127 MAIN ST.
TEL. 2125
Experience
Remodeling
tions
nts and Dresses
Order
gains
Days
store
00
OW

CE!
S
ms
ber of
Try it.
NK
- 1161

BALLARDVALE

Mrs. Ruth Green, Correspondent, Telephone 2634-M

Joint Birthday Party

Craig and Kent Warner, sons of Mr. and Mrs. Albert T. Warner, 12 High st., whose birthdays both fall in January entertained a group of their friends at their home Saturday. Craig was 11, Jan. 8 and Kent 9, Jan. 28. Games were

played and a luncheon was served at noon. Those present were: Robert Newcomb, Donald Kupis, Richard Smalley, Harry Fisher, Charlotte Bentley, Donald McNally, Ruth Perry, Ruth Hall, Daniel McIntyre, George Bentley, David Machen, Robert Read, Allan Taylor, Virginia Hall, Joan Haggerty, Dianne Maruzzi, Donald Brouck and John McIntyre.

Bowling League

The results of the Val-e-roll bowling league for last Friday night are as follows: Atoms 3, Rockets 1; Jets 3, Flying Saucers 1; Bombardiers 4, Migs 0. High single, Barbara Demers 104; high triple, Barbara Demers 284; high pinfall, Jets 934.

Fridays games: Jets vs. Bombardiers; Flying Saucers vs. Atoms; Rockets vs. Migs.

**AUTO
INSURANCE
PREMIUMS
FINANCED**

**ANDOVER
FINANCE CO.**

2nd Floor — MUSGROVE BLDG
ANDOVER SQUARE
TEL. ANDOVER 1998

MEN'S

TROUSERS

WOOL & RAYON

GABARDINES 8.95

In your choice of Tan, Brown,
Blue, Grey or Green.

2-PLY, 100% WOOL
GABARDINES \$12.95

GRAY FLANNELS

In three shade gradations: Light,
Medium or Dark. Slacks with or
without pleats.

\$10.95

\$12.95 and \$15



WORSTED
GREY
FLANNELS
13.95

Flander & Swanton

Andover, Mass. INCORPORATED Exeter, N. H.

It's Easier Now Than Ever
To Have The Used Car
You Want—
LOW PRICES

| | | | |
|-------------------------------|---------------|---------------------------|---------------|
| '50 BUICK 2-door Dynaflo | \$995 | '49 BUICK Super 4-Door | \$895 |
| '51 BUICK Roadmaster 4-Dr. | \$1295 | '51 DESOTO Convertible | \$1495 |
| '51 CHEVROLET 2-Door Sedan | \$1095 | '51 BUICK Convertible | \$1595 |

LOW DOWN PAY'TS

AS LOW \$100 DOWN
AS

| | |
|------------------------------|---------------------------|
| 1949 Ford 2-Door | 1949 Hudson 4-Dr. |
| 1948 Chrysler 4-Dr. Super | 1948 Buick Convertible |
| 1949 Buick 4-Door | 1947 Olds 2-Door |

LOW MONTHLY PAY'TS

AS LOW \$30 A
AS MONTH

| | |
|--------------------------------|---------------------------------|
| 1947 Chevrolet 2-Door Sedan | 1947 Oldsmobile 4-Door Sedan |
| 1946 Buick Conv. | 1948 Packard 4-Dr. |
| 1947 Buick 4-Door | 1947 Chrysler 4-Dr. |

Valentine Party

The women of the Methodist church will entertain the men at a valentine party at 8 p.m., Saturday, Feb. 13 in the vestry. Mrs. John Wilson and Mrs. Andrew Townsend will be in charge of the entertainment, and Mrs. George Davison, Mrs. Henry Burbine, Mrs. John Duke and Mrs. Henry Meyers will serve refreshments.

W.S. of C.S.

The Women's Society of Christian Service held a short business meeting and social in the Methodist church vestry last Thursday evening. Mrs. John Wilson had charge of the devotional service. After the business meeting a "swap party" was held with Mrs. Wilson in charge. Mrs. Wilson and Mrs. Edna Lavin served refreshments.

The next meeting will be held Feb. 25 in the parsonage with Mrs. Gerry Worthen and Mrs. Arthur White Jr., hostesses.

Those present; Mrs. Henry Burbine, Mrs. George Davison, Mrs. Charles Coolidge Sr., Mrs. Gerry Worthen, Mrs. Andrew Townsend, Mrs. Edna Lavin, Mrs. John Wilson, Mrs. Anthony Perrino, Mrs. John Duke, Mrs. Anna Hess and Mrs. Henry Meyers.

Mrs. Anthony Perrino, Mrs. John Wilson and Mrs. Henry Meyers will serve with the South church at the University of Life, Sunday Feb. 21.

Cub Hike

Den 8, pack 73 held its meeting last Monday afternoon at the home of the den mother, Mrs. Alce Taylor 26 Hall ave. Donald Milligan, den chief took the boys on a hike. They then returned to the Taylor residence and Mrs. Taylor served them hamburgers, hot dogs, ice cream and cake. She then took them all to the basketball game (Church league). Some of the boys are members of the team.

Boys in the den are; David Lawrie, Robert Read, Donald Brouck, Allan Taylor, Kent Warner, Robert Shaw, and David Townsend. All participated in the hike except David Townsend, who was ill.

Sports Club

The Ballardvale Sports club held its meeting last week in the Union Congregational church vestry. Films on the Hawaiian Islands and

Italy were shown. Refreshments were served. Russell Robinson and Gene Pimpare were initiated into the club. Due to the illness of the Rev. Anthony Perrino, the Rev. Raymond Wilbur was in charge. Members present; Paul Bouleau, Richard and Fred Lawrence, James Green, Clifford Sharpe, Lawrence Riley, Paul McFarlane, David Robinson, Russell Robinson and Gene Pimpare.

The club will hold its banquet Saturday Feb. 28. Tickets will soon be on sale.

Surprise Party

Miss Prudence Pimpare, daughter of Mr. and Mrs. Leo E. Pimpare of River st., was tendered a surprise birthday party at the home of Miss Margaret Bouleau, 337 Andover st., to observe her 15th birthday. Games were played and dancing enjoyed. Refreshments were served by Mrs. Joseph Bouleau.

Those present; William Lawrie, Clifford Sharpe, Joan Wilson, Carol Evans, Richard Lawrence, Paul Bouleau, Richard Doucette, Joan Jedrey, Richard Nolin, Margaret and Janet Bouleau, Gene Pimpare, Lawrence Riley, Paul McFarlane, Thelma Sparks, Ann Froburg, George Johnston, Patricia Smalley and Prudence Pimpare.

Pop Concert

Boy scout Troop 76 will hold a pop concert in the community room at 8 p.m., Saturday. This event is being sponsored by the mothers to help defray expenses for the Washington trip.

The following program will be presented: song, Ballardvale Mariners, Donald and Fred Lawrence, Roy Sharpe and Richard Smalley; trombone solo, Bruce Meyers; solo, Robert Haggerty; song and dance, Beverly Sparks; trumpet solo, Carl Buschmann; songs, Everett Collins and his men; intermission, refreshments served by mothers and boys of the troop; trumpet solo, the Rev. Raymond B. Wilbur; duet, Linda Mitchell and Gail Smeltzer; solo, Roy Sharpe; magician, Mr. Fletcher; piano solo, Ralph Buschmann; motion picture "Washington the Shrine of American Patriotism" shown by John A. Foote, representative of B. and O. RR.

Flowers

The Flowers on the altar of the Union Congregational church Sunday were given by the Pilgrim Fellowship and later distributed to the shut-ins.

Mothers' March

The Mothers' March for polio netted a total of \$263.90 last Thursday evening in Ballardvale, according to a report by Charles Bentley, the leader.

Personals

Mr. and Mrs. James Sparks and son, Kenneth, and daughters, Thelma and Beverly, Mrs. George Sparks, Patricia Fladger of River st., and Mr. and Mrs. John Wilson and daughter, Joan of Dale st., attended a performance of "The Silver Skates" in Boston Sunday.

Mr. and Mrs. Shields Bishop and son, John of Plattersville, N.Y., were the weekend guests of Mrs. Samuel Moody of Andover st.

Mr. and Mrs. William Lancaster formerly of Everett are now residing on Woburn st.

Mrs. Ralph Greenwood Sr., of Tewksbury st., and Mrs. Lionel Buckley of Chester st., attended a performance of "Guys and Dolls" in Boston last week.

Mr. and Mrs. Roland Luken, formerly of Wakefield, are now residing on Woburn st.

The Friendly Guild will hold a rummage sale Thursday and Friday April 1 and 2.

Church Groups Hold Fellowship Parties

Fellowship parties sponsored by members of the South church have been held during the past week and many more are being planned for the coming week.

Mrs. Frederick B. Noss entertained Tuesday at an "At Home" where people of the church gathered for a social time and also enjoyed the opportunity of a tour of the parsonage.

A luncheon was held at the home of Mrs. Roy E. Hardy, Wednesday, with Mrs. Clifford Marshall as co-hostess. Mrs. Walter Mondale opened her home Wednesday, for a very successful tea and small hobby show. The hobbies which were loaned by members of the church created a great deal of interest and were enjoyed by everyone. Co-hostesses were Mrs. Arthur Covert, Mrs. Winston Blake and Mrs. Theodore Tyler.

Mrs. George K. Sanborn of Hidden field entertained at a morning coffee, Wednesday.

Friday evening, Feb. 5, Mrs. H. Allison Morse, 6 Foster circle will entertain at a bridge party at her home. Mrs. Theodore Tyler will be co-hostess.

Mrs. Claude Lamb, 21 Foster circle, will be hostess Wednesday, Feb. 10, at a bridge party at her home. Mrs. H. Allison Morse will be co-hostess.

Mrs. Ann Bond of Main st., is planning a party at a date to be announced later.

NOVEMBER CLUB NOTES

The next meeting of the Art department of the November club will be held at the home of Mrs. L. Denis Peterkin, 45 Salem st., at 3 p.m. Monday, Feb. 8.

L. Denis Peterkin will be the speaker, the subject, "Arthur C. Goodwin — Is He The 'Forgotten Man'?"

The Literature department will meet at 3 p.m., Wednesday, Feb. 10, at the home of Mrs. Edward Nichols, 31 Wolcott ave. Miss Irene Cook will review "The Hills Are Strong" by Walter Ralls Brown, and "My Heart Lies South" by Elizabeth Borpon. Members of the club are welcome.

Mrs. Maymie Wandlers, Mrs. B. O. Sanford and Miss Ann Worden of Dorchester were recent guests of Mrs. Rankin Grant of Woburn st. Mrs. Newell Davis and son, James of Winthrop were the weekend guests of Mrs. Davis's parents, Mr. and Mrs. James Brierly of Tewksbury st.

FREE PARKING ANDOVER TEL. 11-W
PLAYHOUSE

Wednesday thru Saturday
Feb. 3rd thru 6th

PARATROOPER

Alan Ladd — Susan Stephan
3:15 6:15 9:15

PROBLEM GIRLS

Helen Walker — Ross Elliott
1:50 4:50 7:50

Sunday, Monday & Tuesday
Feb. 7th, 8th & 9th

3 SAILORS AND A GIRL

Gordon McCrea — Jane Powell
3:10 6:10 9:10

SAFARI DRUMS

John Sheffield — Barbara Greston
1:45 4:45 7:45

Wednesday thru Saturday
Feb. 10th thru 13th

KISS ME KATE

Kathryn Grayson — Howard Keel
2:00 5:20 8:40

MOONLIGHTER

Barbara Stanwyck — Fred MacMurray
3:50 7:10

**Bargain
Center**

PRICES ARE LOW

Down Payments Are Low

Monthly Payments Are Low

EVERYONE OF OUR CARS CARRIES A

**20,000 MILE
GUARANTEE**

REGARDLESS OF YEAR, MAKE,
MODEL OR PRICE

INSIDE SHOWROOM —

**TAYLOR
BUICK CO.**

INC.

● ALL

Every
Fashion

SPECIAL PUR
Fabulous ass
to enhance yo
zircon and
fully styled, s
Street Floor

Style

VALUES TO
woven fabric,
Shortie and s
White, colors.

Clo

CLOSEOUT S
this ridiculou
handsomely. E
self, for gifti
Street Floor

Ra

SPECIAL PU
in band or fl
40 and 42. Bl
Street Floor

No

REGULARLY
silk kerchiefs
Available in c
desired. Street

Softsp

SPECIAL PUR
type toilet ti
roll. Street F

10

REG. \$3.95 a
suckers and 8
Stripes, Flor
12 to 20, 14½

S

VALUES TO
Jersey Blous
Wool Skirts,
Misses' sizes

Girls'

REGULAR \$2.
derful selecti
blouses. At t
several! Seco

Infants

TABLE OF V
gan Sweaters,
Gro-Slips, Kni
8. Second Floo

● ALL SALES FINAL ● NO EXCHANGES
● NO REFUNDS



SHOP FRIDAY and SATURDAY
9:00 to 5:30

DOLLAR DAYS

More Value-Packed Than Ever at Sutherland's

Everything for Family and Home! Wider Selection! Bigger Savings!

Fashion-Smart Rings

SPECIAL PURCHASE SAVINGS!
Fabulous assortment of costume rings to enhance your every outfit. Simulated zircons and friendship rings. Beautifully styled, superbly crafted.
\$1 Plus Tax
Street Floor

Style-Wise Gloves

VALUES TO \$2.00! Rayon, double woven fabric, cotton string gloves. Shortie and slip-on styles.
\$1
White, colors. Street Floor 2 pr. For

Closeout Nylons

CLOSEOUT SAVINGS! Stock up now at this ridiculously low price and save handsomely. Buy for yourself, for gifting.
\$1
Street Floor 2 Pr. For

Rayon Panties

SPECIAL PURCHASE! Rayon panties in band or flare leg styles. Sizes 38, 40 and 42. Blush shade only.
\$1
Street Floor 2 For

Neckerchiefs

REGULARLY 59¢ EACH! Beautiful silk kerchiefs in 18" squares. All new. Available in any color desired.
\$1
Street Floor 4 FOR

Softspun Toilet Tissue

SPECIAL PURCHASE SAVINGS! Facial type toilet tissue. 1000 sheets to the roll.
\$1
Street Floor 8 Rolls

100 Dresses

REG. \$3.95 and \$4.95 VALUES! Seersuckers and 80-sq. percales. Sanforized. Stripes, florals, plaids. Broken sizes 12 to 20, 14½ to 24½. Second Floor.
\$1 ea.

Sportswear

VALUES TO \$10.95! Sweaters, Jersey Blouses, Wool Vests, All Wool Skirts, Orlon and Wool skirts. Misses' sizes.
\$2.00 and **\$3.00**
Second Floor

Girls'-Teens' Blouses

REGULAR \$2.95 VALUES! A truly wonderful selection of girls' and teens' blouses. At this low price you'll want several!
\$1
Second Floor

Infants'-Children's Wear

TABLE OF VALUES TO \$2.50! Cardigan Sweaters, Dungarees, Cotton Eyelet Grog-Slips, Knit Hats. Broken sizes 3 to 8. Second Floor.
\$1

OUR ANNUAL DOLLAR DAY Sleep Shop Special

A SENSATIONAL OFFER

Box Spring

Only **\$1.00**

With the purchase of our Quality Craft Hair Top Inner-spring Mattress at \$59.50



You get a full bed unit for \$60.50....

This offer includes Single and Full Sizes

TWO DAYS ONLY!

SLEEP SHOP - Third Floor

STANDARD SIZE FOAM RUBBER
PILLOWS \$4.69 ea.

Third Floor Regularly \$5.95

Famous Make Bras

SPECIAL PURCHASE! Famous make bras in white cotton, satin and nylon. Sizes 30AA to 40C. Third Floor
\$1

Girdles-Panty Girdles

SPECIAL PRICED SAVINGS! 2-way stretch girdles in white. Small, medium and large sizes. Also 34 to 42. Third Floor
\$1

Frame Ruffled Nylons

NEVER BEFORE AT THIS LOW PRICE! Frame ruffled, Cape Cod Priscilla Nylons in 54", 63" and 72" lengths. Dainty picot ruffled, Eggshell color. Third Floor.
\$1

Boudior Lamps

A REGULAR \$3.00 VALUE! Boudior lamps imported from Italy. Four hand-painted designs to choose from with pleated shades. Fourth Floor
\$1.50

T.V. Hostess Sets

A REGULAR \$2.95 VALUE! Consists of 4 white tea cups and 4 trays in gray or chartreuse. Fourth Floor
\$1

Cut Glass Stemwear

REGULARLY 49¢ EACH! Choose from goblets, sherbets, ice teas, floral cut all-over with pressed stem. Fourth Floor
29c ea.

Steel Meat Slicer

REGULARLY \$1.25 EACH! Universal, stainless steel meat slicer with wood handle. Fourth Floor
69c ea.

Simtex Place Mats

USUALLY 50¢ EACH! All rayon and cotton. All sanforized. All finest quality. Downstairs.
\$1 6 For

Cannon Towels

USUALLY 89¢ EACH! Slight seconds. Thick and absorbent. Long wearing. Wide range of colors. Downstairs
\$1 2 for

Spring Maid Sheets

Slight seconds, but nothing to impair their wear. 128 super-wear muslin. 72" x 108", usually \$2.39 \$1.89 81" x 108", usually \$2.69 \$2.29



MAKE GOOD CATCH AT HAGGETT'S POND

Two fine pickerel were caught Sunday at Haggett's pond.

George Grudzinski of Highland rd. came up with a 24-inch catch weighing an even four pounds, and Jack McMillan of River st. got one 23½ inches long weighing three and one-half pounds.

48-hr. Service
AT
No Extra Charge

Men's and Women's COATS

(Plain)
Expertly Dry Cleaned and Custom Pressed

69c

Laundry

Shirts . . . 18c

Laundered and Refinished

CITY CLEANERS
LAUNDERERS and DYERS

35 MAIN ST. ANDOVER

WEST PARISH

Mrs. Sarah Lewis, Correspondent, Telephone 584-J

4-H Night

Thursday evening, Jan. 28, at the North District schoolhouse 4H night was observed when 33 4-H boys and girls and their parents were the guests of the N.D.I.A. Following the regular monthly business meeting the boys and girls gave a resume of their achievements during the past year.

The girls, who call themselves "The Busy Wizards" and hold their meetings weekly under the leadership of Mrs. Russell Holmes, gave a demonstration 4-H meeting, starting with their pledge. Their president, Nancy Hird, conducted the meeting and the secretary's report was read by Beverly Hird. This report listed the past activities and included future plans. They recently completed a project of selling 4-H cookies to help defray expenses to Camp Leslie. They have arranged a trip to a silver company in Newburyport, wish to visit a woolen mill, and will hold contests, judging fashion and win-

dow displays.

They displayed their projects: knitting, crocheting, beginner's and advanced sewing.

Mrs. Holmes is assisted in her work with these girls by Mrs. Andrew Fischer, Mrs. Delphine Sullivan and Miss Grace Tricky.

The cooking classes of the group, which are led by Mrs. Clarence Sanborn and Mrs. James Smith, supplied an attractive assortment of cookies for the refreshment table.

Under the leadership of Austin Basso the boys gave a most impressive recital of their list of prizes won in various fields.

Joseph Basso won the sweepstakes award at Topsfield fair with a New Hampshire pullet and second prize for a dozen large eggs. He won third prizes at the Boston Poultry show for a New Hampshire hen and a dozen eggs.

Ronald Tellier received the following: 6th prize in the Chicken of Tomorrow contest at Brockton; second and third prizes on eggs at the Boston Poultry show; first and second prizes at Topsfield for White American pullets.

Santo Ardizzone received first and second prizes at the Topsfield fair with his New Zealand white rabbits and a second prize at the Boston Poultry show.

Walter Potvin, Ronald Tellier and Joseph Basso received a first prize at Topsfield with a forestry exhibit. Walter Potvin also received first prize for a dozen large eggs at the Boston Poultry Show.

Bernard Levesque has received a second prize for his watermelon.

Arthur Levesque received first prize with seven White Americans in another contest. He received a first and two second prizes with vegetables. Recently he received a fine large Holstein cow for outstanding work in 4-H.

Barry Skiba received first prize with a New Zealand white rabbit and a first and second for vegetables.

Daniel Sheehy received second prize with a New Zealand white rabbit and for his vegetables one first and two seconds.

Grange Notes

Andover Grange was the guest of North Andover Grange on Monday evening when they celebrated their Past Master's night.

The Help-A-Long club of the grange will meet tonight at the home of Mr. and Mrs. Theodore Peterson on Pine st. Any Grange members are welcome.

Friendship Pomona Grange will meet in West Boxford Saturday, Feb. 6, for an afternoon and evening meeting, starting at 4:30 o'clock. Supper will be served by the West Boxford members.

On Feb. 9 the regular meeting of Andover Grange will be held with an illustrated lecture by Miss Louise Sherman. Refreshments will be served by a committee headed by Mr. and Mrs. Michael Bell.

Notes

The monthly square dance will be conducted at the West Parish vestry at 8:15 p.m., Feb. 5.

The beautiful flowers on the altar of the church last Sunday were the gift of Mrs. Frank Hardy in loving memory of her husband.

The Junior Woman's Union will hold its February meeting at 8 p.m., Thursday, Feb. 11. Mrs. Clayton Northey, the president, will preside and plans for the year will be discussed.

A regular meeting of the Busy

Wizard 4-H club of Andover was held on Jan. 21 at the home of Mrs. Philip Holmes on River rd.

Personals

The Lathrop Merrick family have moved from their former home on Shawsheen road to their newly built home on Canny road, Durham, N.H.

Mr. and Mrs. Wolfgang Berthold, from New Jersey, have moved into the Merrick house on Shawsheen road.

Mr. and Mrs. Archibald MacLaren Jr., have moved into their newly built home on Reservation road.

Patricia Lewis, daughter of Mr. and Mrs. Roger Lewis of Laurel lane, fractured her arm while at play on the West elementary school grounds and is confined to the Lawrence General hospital.

Visiting at their homes following midyear exams are Bruce Stewart and Richard Hudgins from Norwich university, Judith Marland and Tony Sullivan from University of Massachusetts and Arlene Pariseau from Lasalle Junior college.

The many friends of Mrs. Margaret Little of Shawsheen road were grieved to learn of the death of her mother, Mrs. Jones, who had lived with Mrs. Little for many years.

B.P.W. TIGHTENS REGULATIONS

(Continued from Page One)

meshing with planning and zoning requirements.

The board's particular interests center around the roadway and utility features of any proposed subdivision, it being the board's duty to report favorably or unfavorably on the general fitness of private ways for acceptance when so requested by the Selectmen. For sometime the Board of Public Works has had fairly well defined requirements for roadway, sewer, water, and drain construction. These requirements, altho in effect for sometime prior, were published in August of 1952 for the first time.

It is believed that the planning board may adopt, or be empowered to adopt, certain similar regulations and requirements under articles planned for insertion in the 1954 annual town meeting. This is felt to be a further step in the right direction toward improving the general welfare of Andover and its citizens. The board of public works favors this as an additional means of enforcing their regulations.

Under the present arrangement the board of public works will not recommend the acceptance of a private way unless the following requirements have been met to the board's satisfaction:

1. Roadway right-of-way cleared of all obstructions other than desirable shade trees.

2. Traveled way and shoulders to be properly constructed of suitable materials, to proper depth, cross section, and profile in conformance with the acceptance plan and on a suitable sub-grade.

3. Sanitary sewer mains and appurtenances, constructed in accordance with good engineering practice. In locations where sewers cannot be drained to the town sewer system by gravity this requirement may be waived.

4. Water mains and appurtenances, including hydrants for fire protection, constructed in accordance with the present and future requirements of the water department.

5. Surface water drainage system including catch basins, ditches and piping where necessary to properly dispose of all storm water together with legal easements for storm drainage where necessary.

Item (2) above has recently been amended to include the requirement of a two coat surface treatment of road tar or asphalt on all streets proposed for acceptance after the annual town meeting of March 1954.

The foregoing is a brief summary of the minimum requirements set forth in the board's "Construction Requirements For Private Ways Which Are To Be Petitioned For Accepting As Town Public Ways". Copies of these requirements are available at the town hall, and all real estate developers, builders, engineers and other interested persons should familiarize themselves with their contents before entering into land development work in Andover.

These requirements are established and maintained for the good of the town and its residents; for the purpose of assessing the costs of normally accepted improvements against the land directly improved, rather than calling on all property owners of the town to pay, via taxes, for the development of special land areas. This would be the case were unimproved streets to be accepted casually; because human nature is such that what suffices very well for a private way no longer satisfies the residents of a street once that street becomes an accepted street. Hence almost immediately demands would arise for water mains, sewer mains, drainage facilities, etc., were they not already in place before acceptance.

It is felt that the firm enforcement of these requirements results in a better town and in greater fairness to the majority of taxpayers. At the same time it tends to reduce the number of half-hearted or dormant subdivisions, of which there have been so many in the past.

AN UNDIVIDED RESPONSIBILITY
We SELL INSTALL SERVICE GUARANTEE
MEMBER NATIONAL ASSOCIATION OF MASTER PLUMBERS

BUCHAN
and
McNALLY

PLUMBING & HEATING CO.
26 PARK STREET
TEL. AND. 121

WESTINGHOUSE LAUNDROMAT

for only

\$199⁹⁵

BUDGET TERMS

Completely Automatic

FULL SIZE

Holds 9 lbs. dry clothes. Has famous Agi-Tumble washing action. And completely automatic from start to finish. Why be without one at this low price?

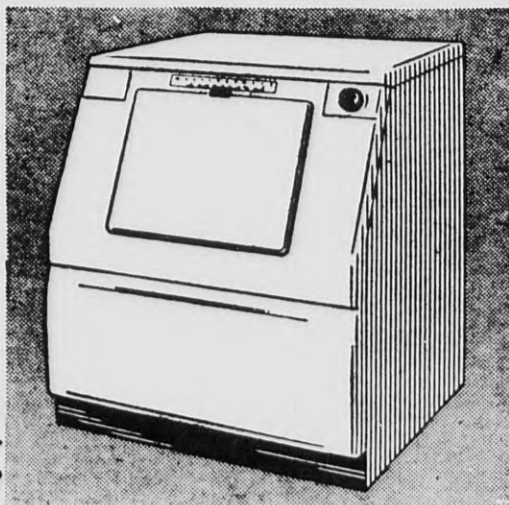

Model LS-7

Come in—see it perform!

Lawrence Electric Company
PART OF NEW ENGLAND ELECTRIC SYSTEM



ELECTRICITY IS CHEAP YOUR BIGGEST HOUSEHOLD BARGAIN

Balance of Winter Stock Reduced to
5 Sale 1/2 PRICE
Michael Jay's



Principals
Baptist church of four years
E. Nelson Jr.
Thompson, secretary
burn B. Hathaway

PLANNING BOARD DISCUSSES ZONING

(Continued)

ters, has two arti-

tion in the town.

The first is to

laws to provide

in single residen-

The second to

tor appoint a com-

mittee to study zo-

appropriate \$2500

John Radford

became chairman

of persons.

Atty. Fredric S.

L. Miller, Dona

Eric Jones, Roge

eight Bright.

The amendment

law is regarded as

gap, says the com-

mittee made this w

"The zoning p

ver," the stat

"have become so

intensive study w

deal with them

committee strongl

fessional aid shou

"The present co

meeting meeting

ception, including

cal builders and

vited, and anothe

Planning board.

"The purpose

has been to deter

zoning regulations

future developme

recommending i

necessary.

"The committee

favor of immedi

since the time ha

for adequate stud

ing temporary

divisions by mea

lot sizes and front

"Within circle

around the town h

mile around Balla

and Shawsheen

square feet lots w

tages are to be r

yond those limits

foot lots with 150-

THE MA

RADIO

KNUE

286 ESSEX ST

PIANOS



Principals in the service of progress held last Sunday at the Baptist church when the 20-year mortgage, which was disposed of in four years, was burned. From left to right, The Rev. Roy E. Nelson Jr., pastor; Clinton H. Stevens, clerk; Thomas A. Thompson, senior deacon; Charles A. Stone, treasurer, and Raeburn B. Hathaway, moderator. (Look Photo)

SALVATION ARMY CAMPAIGN OPENS

(Continued from Page One)

Main st. In announcing the opening of the drive in Greater Lawrence for the annual quota of \$30,000, Major Ernest Baxendale, officer in charge, expresses his satisfaction and appreciation in having valuable support of interested business and professional men and women behind this campaign, those who have rendered service for a number of years and others who have recently volunteered their services.

Roy E. Hardy is honorary chairman of the local committee and Atty. Gordon general chairman. Others include Raymond S. LaRoas, campaign chairman; Lenore D. Macartney, treasurer; Mrs. Frank E. Himmer, special gifts; Miss Olive Butler, women's division; David P. Cardinal, veterans' division; G.

Homer Judge, industrial division; and Alexander H. Rogers II, public Francis X. Beirne, town employees; licity.



by
Whitman - Candy Cupboard
Paige & Shaw
50¢ to \$6.00

Hartigan Pharmacy
TEL ANDOVER 1006
66 MAIN ST. ANDOVER, MASS.

PLANNING GROUP DISCUSSES ZONING

(Continued from Page One)

ters, has two articles for consideration in the town warrant.

The first is to amend the zoning laws to provide larger house lots in single residence districts; and,

The second to have the moderator appoint a committee of seven or nine to study zoning problems and appropriate \$2500 therefor.

John Radford Abbot, architect, became chairman and named the following persons to the committee: Atty. Fredric S. O'Brien, Norman L. Miller, Donald B. Look, Mrs. Eric Jones, Roger Lewis and Raleigh Bright.

The amendment to the zoning by-law is regarded as a temporary stop-gap, says the committee in a statement made this week.

"The zoning problems of Andover," the statement continued, "have become so complex that much intensive study will be required to deal with them adequately. The committee strongly feels that professional aid should also be sought."

"The present committee has held frequent meetings since its inception, including one to which local builders and realtors were invited, and another jointly with the Planning board.

"The purpose of the committee has been to determine whether the zoning regulations allow for proper future development of the town, recommending improvements if necessary.

"The committee is strongly in favor of immediate action, and since the time has been too short for adequate study, is recommending temporary control of subdivisions by means of increasing lot sizes and frontages.

"Within circles of one mile around the town house and one-half mile around Ballardvale fire station and Shawsheen square, 15,000 square feet lots with 125-foot frontages are to be required, and beyond those limits, 25,000 square foot lots with 150-foot frontages.

"Eventually it is hoped that the boundaries of the different districts will be determined by street lines, after adequate study and consultation with local experts including the board of public works, the board of health, the town engineer and the school committee...."

"A two-thirds majority vote of the town meeting is required to make any changes in the zoning by-law."

"The committee feels that due to the relocation of Route 28 and the opening of the new Western Electric plant in North Andover that Andover "is faced with subdivisions of numerous small houses on an unprecedented scale."

This, it found, was the experience of the town of Natick. "As a result," it says, "the tax rate has gone up \$7 this year and is going up another \$7 next year to provide for schools, sewer extensions and other town services."

Citing the town of Lexington which has recently increased lot-size requirements, the committee says: "Mr. Abbot received the information from the chairman of the Lexington Planning board that their biggest problem has been out-of-town developers desiring to build subdivisions of 100 or more small houses. Lexington's population has increased 50 percent since 1947 due primarily to two new express roads, the Concord turnpike and Route 128".

The committee on town affairs of the League of Women Voters also attended the meeting the committee held with the planning board and a report will be given at the next unit meetings to be held at 9:45 a.m., Feb. 9 in Williams Hall, and at 7:45 p.m., at the home of Miss Helen S. Yeau. Mrs. Eric Jones, a member of the committee who is serving as secretary of the lay committee, will give the report.

Cause or Effect

Parents soon earn from the sound whether their new-born baby is crying for cause or effect.



HIGH SCHOOL SENIORS!

Your Chance to Win
a Four Year
College Scholarship

106
AWARDS

\$8,000
TOTAL

Go On The Air
in this Smart New
Safety-Quiz Radio Show

"FORUM FOR LIVING"

Starting March 6

- | | |
|----------------------------|----------------------------|
| BOSTON WEEI | LAWRENCE WLLH |
| WORCESTER WTAG | FALL RIVER WSAR |
| SPRINGFIELD WMAS | PITTSFIELD WBRK |
| HYANNIS WOCB | NEW BEDFORD WNBH |

FORUM FOR LIVING is a public service program designed to help you and the members of your family live safer, happier lives. By taking part, you will be making a valuable contribution to safer living in Massachusetts and at the same time have opportunity to win U. S. Savings Bonds and valuable four-year scholarships. Open only to seniors in public, private and parochial schools in Massachusetts. Don't miss this opportunity. Enter today. If FORUM FOR LIVING entry forms are not available in your school, or at your local newspaper office or radio stations, send the coupon below to "FORUM FOR LIVING".

Presented By
**CASUALTY INSURANCE COMPANIES
SERVING MASSACHUSETTS**
in cooperation with
**MASSACHUSETTS REGISTRY
OF MOTOR VEHICLES**

TO: FORUM FOR LIVING
Casualty Insurance Companies Serving Massachusetts
8 Beacon Street
Boston 8, Mass.

I would like to take part in your FORUM FOR LIVING safety program. Please send a copy of the preliminary questionnaire and the official rules to me.

Name _____
Address _____
City _____ State _____

ASK YOUR SCHOOL PRINCIPAL OR
GET YOUR QUESTIONNAIRE BY
SENDING YOUR COUPON TODAY

THE MAGNIFICENT **MAGNAVOX**

RADIO PHONOGRAPH TELEVISION

KNUEPFER & DIMMOCK

286 ESSEX ST. LAWRENCE OPP. EAGLE TRIBUNE
PIANOS - RADIOS - FRIGIDAIRE - LUGGAGE

RESPONSIBILITY
SELL
INSTALL
SERVICE
WARRANTY
REGISTRATION OF MASTER NUMBERS

CHAN
and
WALLY
& HEATING CO.
100 K STREET
AND. 121

of
Stock
duced to
PRICE

PRISCILLA ABBOT CHAPTER

Priscilla Abbot chapter, N.S.D. A.R., will meet at 2:30 p.m., Tuesday, Feb. 9 at the home of Mrs. Wilson Knipe Jr., 1 Stratford rd. A representative of a large paint company will speak and show a film on home decorations.

JACKSON LUMBER

CO. INC.
The Department Store
for Home Builders

LUMBER
HARDWARE
AND A COMPLETE LINE
OF BUILDING MATERIALS

10-12 JACKSON ST.
LAWRENCE

TEL. 4141

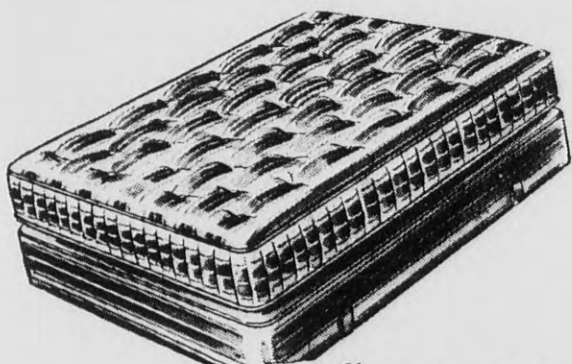

Stop "Soft-Bed"
Backache!

IN THIS NATIONAL

SALE!

Now you don't have to pay up to ~~\$79.50~~
for this healthful button-tufted



"Posture-Ease"
EXTRA-FIRM MATTRESS

Now Only **\$39.75**
FULL OR
TWIN SIZE

SULLIVAN'S
THE BIG FURNITURE STORE

226 ESSEX ST.

LAWRENCE

TEL. 6157

SHAWSHEEN

Mrs. Helen Caswell, Correspondent, Telephone 62

PTA Fair

Andrew Innes is general chairman in charge of the PTA fair, which will be held in the school hall beginning at 7:30 p.m. Wednesday, Feb. 10. There will be grabs, mystery packages and balloons for the children, bakery, plants, preserves, and white elephant tables for adults, and games and refreshments for all. The PTA fun night has come to be annual institution, and is the only money-making affair, run by the association, during the year. Committee chairmen for the various tables are: Refreshments, Mr. and Mrs. Arthur Walsh; bakery, Mrs. Hollis Fowler; grabs, Mrs. Joseph Drouin; mystery packages, Mrs. James O'Reilly; white elephant, Mrs. Ralph Milliken; preserves, Mrs. James Baxter; plants, Mrs. John Wholey; games, Paul McKinnon, and decorations, Mr. and Mrs. James Wilson.

Polio Dance

For the purpose of raising a contribution to the March of Dimes polio fund, a group of eighth grade students held a dance at the home of Mr. and Mrs. James Byrnes of Lowell st., last week. The chil-

dren decorated the playroom in Punchard colors of blue and gold, danced to the music of records and enjoyed refreshments of hot dogs and coke. They took up a collection of \$6.50 which they contributed to the polio fund. Those present were: Hartwell Abbot, Jimmy Clegg, Philip Colquhoun, Bob Colpitts, John Fitzgerald, John Giovinco, Fred Hall, Bob Nicoll, Buddy Simeon, Ted Sutton, Carol Becotte, Helen Ellis, Linda Fisher, Marilyn Freeman, Beverly Bird, Betty Ann Luminello, Sandra McBride, Mary Cafferty, Linda McCarthy and Dorothy Byrnes.

Womans Club

The Shawsheen Village Woman's club met Monday evening in the school hall with the president, Mrs. G. Edgar Best, presiding. Minutes of the last two meetings were read by the recording secretary, Mrs. T. Edwin Andrew Jr., and the corresponding secretary, Mrs. Raymond Pearl, read the call to the mid-winter meeting of the Massachusetts State Federation of Women's clubs which will be held in Boston Thursday, Feb. 18. Mrs. Wallace Fiedler, program chairman, introduced John and Deana Sweets, who presented three original sketches - one of Queen Victoria and Prince Albert, one of two old people meeting again at their 50th college reunion, and one of a young married couple concerned with calories and waistlines. Refreshments were served, during the social hour by Mrs. James Baxter and Mrs. John Guild and their committee of hostesses, with Mrs. F. Jerry Leone presiding at the coffee urn.

Literature Department

There will be no meeting of the literature department of the club this month due to uncertain weather conditions. Book reviews with Mrs. Lewis Putnam will be resumed in March.

American Home Dept.

The American Home and antique study group will meet at the Historical House on Main st., at 2:15 p.m., Friday, Feb. 12.

Personals

Miss Jane Anne MacAskill, a student at the University of New Hampshire, has been spending the mid-year vacation with her parents, Mr. and Mrs. Everett MacAskill of Sutherland st.

Joseph Byrne, son of Mr. and Mrs. Joseph Byrne of Canterbury st., has completed his studies at Cornell university, and is spending a few days with his parents before leaving for Akron, O., where he will be employed. He received his commission as second lieutenant in the army after completing the ROTC course at the university in June, and will report for active service in a few months.

Richard Guild, son of Mr. and Mrs. John Guild of Chandler circle, has returned to his home after being a patient at the Children's hospital in Boston.

James Baillie, son of Mr. and Mrs. Andrew Baillie of Carlisle st., has returned to Bowdoin college, where he is a member of the junior class, after a midyear vacation at the family home.

Mr. and Mrs. Wallace Fiedler and daughter, Karen, moved into their new home on Chandler circle over the past weekend.

Jo-Anwyl Foster, daughter of Mr. and Mrs. Robert Foster of Dumbarton st., spent the weekend with her grandparents, Mr. and Mrs. Harold Davis of Waltham.

Visiting Nurse Assn. Opens Drive Feb. 8

The executive board of the Visiting Nurse Association of Andover, Inc., has decided to start the annual drive for funds Monday, Feb. 8. Once again this year because of the fine response, the same method of mailed notices will be used.

Due to rent and salary increases, it is hoped that all members and non-members will increase their donation by 10 percent. All non-members who fail to receive notices are urgently requested to call the office, 1821, and a notice will be sent at once.

The executive board appointed Mrs. John C. Young, prominent in community activities, as acting secretary to fill out the balance of the fiscal year.

Engagements

McCabe - Boyers

A summer wedding is planned by Miss Catherine J. Boyers, whose engagement to Robert S. McCabe, son of Mr. and Mrs. Arthur S. McCabe of Rocky Hill rd., has been announced by her parents, Mr. and Mrs. A. S. Boyers, 71 Hidden rd.

Miss Boyers attended the Robinson school in Puerto Rico and is now a senior at Punchard high school. Mr. McCabe is a graduate of Punchard high school and attended Miami university, Miami, Fla. He is now employed by the A. and P. Corrugated company, Lawrence.

Begley - Cookson

A fall wedding is being planned by Miss Mary Louise Cookson, whose engagement to Arthur A. Begley, son of Mr. and Mrs. John Begley, 20 Whitman st., Lawrence, has been announced by her parents, Mr. and Mrs. Francis R. Cookson, 123 Main st.

Miss Cookson attended Sacred Heart academy, Fairhaven, was graduated from Punchard high school, and attended the McIntosh school, Lawrence. She is employed by the Andover Savings bank. Mr. Begley attended Lawrence high school and is employed by Cherry & Webb's.

Wood - Michaud

The engagement of Miss Bernadette Michaud to Bedford Harold Wood Jr., son of Mr. and Mrs. Bedford H. Wood, 8 Highland ave., has been announced by her parents, Mr. and Mrs. Alfred Michaud, 45 Plymouth st., Methuen.

Miss Michaud is a graduate of the Edward F. Searles high school, Methuen, and is employed by Western Electric. Mr. Wood is a graduate of Punchard high school, and is now in the navy stationed at Newport, R.I.

Police Ask Right To Register Bikes

In the interests of bicycle owners and as an aid to police the voters at town meeting will be asked to accept an article relative to the registration of bicycles.

Andover is the only community in this area that does not have bicycle registration. If the article is accepted it will give the police department the right to issue certificates of registration with the name of the applicant, his age, make of bicycle and the manufacturer's serial number.

A registration plate is then issued to be attached to the vehicle. The fee is 25 cents and the registration is good for the life of the bicycle or until it changes hands.

Police Chief David L. Nicoll estimated that there are at least 2000 bicycles in use in town. About 25 are reported lost each year, many of which are never claimed. The registration plate would enable police to contact the rightful owner as soon as the vehicle is located.

Red Cross Notes

Frank W. Lilley 260 N. Main st., has been appointed vice chairman of the local Red Cross blood program. Before moving to Andover, Mr. Lilley was deputy administrator of the New York regional blood program in the Greater New York Red Cross chapter. As part of his volunteer work here he will represent Andover at all regional blood program meetings. Sidney P. White will continue as chairman of the blood program.

Proposed For Relocation Of Routes

Proposed relocation of I-93 and relocation of I-93 and I-93 have been submitted and towns affected they might expect which of the other the problem.

The proposed Route 28 from line to the area would pass one in the other the other easter.

Public Works A. Volpe stress are tentative under no circumstances construed as a proposed relocation immediate ever funds are available but the department have its plan that construction more rapidly available.

Before outlining routes Commission that people r business on or get unduly distressed of properties in the final notice to make adjustments of ness locations.

The proposed would enter Andover Junction, parallel to the center road between roads, cross I-93 street) between roads, cross I-93 of the junction cross the Merrimack new bridge, pass Anne's orphanage west of the Methuen to the New H.

The proposed would enter Andover Parker state fore old military po Route 114 west cross the junction and Salem street go east of North cross to the east turn northwestern of Sutton's pond mack to a point Burke hospital, the junction of E to Marston's corner the New Hampshire City and town

ALBANY

GOOD

Now you can power-drain a new faster All-Weather with the allowance more because battery is priced that

Albany

314 So. Br

Proposes Plans For Relocation Of Route 28

Proposed alternate plans for the relocation of Route 28 through Andover and adjacent communities have been submitted to the cities and towns affected in order that they might express their views on which of the two would best solve the problem.

The proposed relocations of Route 28 from the New Hampshire line to the Metropolitan Boston area would pass through Andover, one in the westerly section and the other easterly.

Public Works Commissioner John A. Volpe stressed that these plans are tentative and explanatory and under no circumstances could be construed as a guarantee that the proposed relocation would be an immediate eventuality. He said no funds are available for the project but the department intended to have its planning well along so that construction could be started more rapidly when funds were made available.

Before outlining these tentative routes Commissioner Volpe urged that people residing and doing business on or near the lines not get unduly disturbed. He said owners of properties that are included in the final line will be given ample notice to make any necessary adjustments of residential or business locations.

The proposed westerly route would enter Andover west of Lowell Junction, pass westerly of Ballardvale center, cross Dascomb road between Lovejoy and Clark roads, cross Route 133 (Lowell street) between Lovejoy and Argilla roads, cross River road just west of the junction of North street, cross the Merrimack river over a new bridge, pass to the west of St. Anne's orphanage in Lawrence and west of the Methuen business center to the New Hampshire line.

The proposed easterly route would enter Andover in the Harold Parker state forest just west of the old military police camp, cross Route 114 west of Boston Hill, cross the junction of Marbleridge and Salem streets in North Andover, go east of North Andover Center, cross to the east of Stevens pond, turn northwesterly to the east side of Sutton's pond, cross the Merrimack to a point just west of the Burke hospital, cross Route 110 at the junction of East street, continue to Marston's corner and westerly to the New Hampshire line.

City and town officials have been

Would Cancel Action On Rent Control

The selectmen Monday night voted to insert an article in the town warrant to see if the town will vote to rescind the action taken at the special town meeting last August which continued rent control here.

The article adopted at that time declared that a shortage of rental housing accommodations existed here and that control of rents was necessary in the public interest.

After the rent control was established and opened an office in the town house it had very little business to transact. It held a public meeting about two weeks ago to learn if a substantial rental housing shortage existed, and shortly afterward voted to decontrol maximum rent ceilings. The board still remains in existence and continues its regular office hours from 2 to 5 p.m., Tuesdays at the townhouse.

A large delegation from Johnson acres was present at the meeting in support of a petition to allow Cheever circle to be used for coasting. Only the week before this was taken off the list of streets for coasting.

After the hearing the board decided to continue coasting on the street.

A change of management at Fred's Lunch, Inc., 19 Essex st., from George W. White to Lewis S. Clement, at present a resident of Ipswich, was approved by the board subject to approval of the ABC commission.

A delegation was present from Sutherland street in support of a request to have the town accept as a public way Sutherland Street extension.

It was explained to the delegation that the board of public works is having difficulty in approving that extension because of the sewerage and drainage problem there due to the contour of the land. The proposal is still under study.

ESCAPES INJURY IN AUTO ACCIDENT

Mrs. Thomas A. Farragher, 65 Carmel rd., escaped injury when an automobile she was operating Monday morning skidded on the ice opposite 160 High street, went through a fence and over an embankment, according to a report by Andover police. Patrolman Robert Deyermond investigated.

provided with an outline of these routes and have been requested to submit their comments within 60 days.

Subscribe to the TOWNSMAN

Follies Program Committee Meets

Members of the program committee of the Follies of '54 were entertained recently by Mrs. Roland H. Sherman at a coffee hour in her home. With her as co-chairman of the committee was Mrs. Harry Axelrod who will be hostess at the next meeting to be held Feb. 19.

Also present were Mrs. Horace N. Stevens Jr., and Mrs. Dean K. Webster, joint chairmen of the Follies to be given Apr. 29 and 30 at the Tenney auditorium, Methuen. Proceeds are to go to the Lawrence General hospital.

Other members of the program committee who attended were: Mesdames John Cecill, George Goodman, John Hawes, Daniel Hogan, Edward Nicholls, Richard Quint, Walter Tomlinson, William Washburn and Ernest Wilkinson.

A.P.C. Sorority To Meet Tonight

Members of the Alpha Phi Chi sorority of South church will meet tonight at 7:45 p.m., in the vestry. Please note the change of time for this meeting.

A "Chemical Magic" demonstration and also a film entitled "Decision for Chemistry" will be presented by Emery N. Westcott.

Husbands and friends of A.P.C. members interested in chemistry will be welcome at 8:30 p.m.

Mrs. Paul Simeone is refreshment chairman, assisted by Mrs. William Urquhart, Mrs. Howard Watson, Mrs. George Collins, Mrs. Byron Clark, Mrs. Joseph Wright and Mrs. Cornelius G. S. Banta.

CENTRAL PTA TO HEAR SCHOOL BOARD CANDIDATES
Candidates for the school com-

mittee have been invited to speak at the next meeting of the Central Elementary PTA to be held Wednesday evening, Feb. 10. After the talks there will be an opportunity for questions from the floor.

W. H. **WELCH** CO.
— TEL. 128 —
PLUMBING and **HEATING**

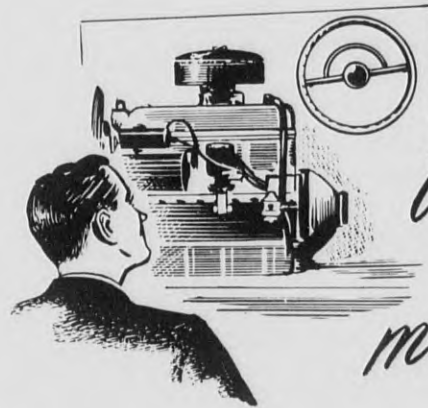

Which Part is most important?

THE ANSWER, as you know, is that the engine and the steering wheel are *equally* important. If either part were missing, the car couldn't function.

The same principle applies to our American industrial system: it takes *both* "Capital" and "Labor" to make it work.

With willing investors to *provide* tools, and skilled workers to man them efficiently, American industry has reached the highest level of production in history — and Americans enjoy the highest living standard.

Would any reasonable person deny the investor's right to a fair return for risking his savings, any more than the worker's right to a fair wage? Of course not.

Communists, however, aren't reasonable people. They desperately want to break up our "winning combination." But when they trot out their phony arguments, trying to set one group against another, Americans just look around them and reply "Our system really *gives* us what you only *promise*. We like what we've got — and we'll keep it!"

Another winning combination: Americans and the nation's banks in which they deposit. Our staff believes that our bank's success depends largely on the success we help our depositors to achieve. On that basis, we invite your account.

The Andover Savings Bank

5 Hampshire St. Methuen

61 Main St. Andover

108 Main St. North Andover

DeLuxe

All-Weather BATTERIES

by

GOODYEAR

Now you can trade that old power-drained battery for a new faster, surer starting All-Weather and save. Save with the liberal trade-in allowance . . . save some more because this great battery is actually lower priced than ever before.



Albert E. Schlott, Inc.

314 So. Broadway Lawrence Tel. 22161

Right Bikes

of bicycle own- to police the v-og will be asked le relative to the cles.

only community does not have m. If the article l give the police ht to issue cer- tration with the licant, his age, and the manufac- er.

plate is then tched to the ve- 25 cents and the 3d for the life of until it changes

vid L. Nicoll es- are at least 2000 t town. About 25 each year, many nd but some of e claimed. The would enable the rightful own- e vehicle is lo

s Notes

y 260 N. Main inted vice chair- Red Cross blood moving to And- was deputy ad- e New York re- am in the Greater oss chapter. As eer work here he dover at all re- gram meetings- will continue as od program.

Scouts Observe Birthday

One of the nation's outstanding organizations, the Boy Scouts of America, is observing its 44th birthday next week, Feb. 7 to 13.

This has been designated as Boy Scout week in honor of the "young men of tomorrow", some 2,440,000 strong, who make up this noted youth group.

These youngsters with their adult leaders enjoy the "game of scouting" in three distinct programs, cub scouting, boy scouting and exploring, each appealing to boys of various age levels.

We seldom stop to think that this great work is made possible largely through the active sponsorship of the church, the school and other community institutions. But perhaps even more significant, is the fact that some 860,000 adults share their time as volunteer leaders with the boyhood of America.

Theirs is a devoted service. A large number have served many years.

Boy Scout week this year has been dedicated to honoring the cubmasters, the scoutmasters and the explorer advisors, — the men who bring scouting directly to the boys.

It is their influence on the scouts of today that help mould these boys and young men into better citizens and better proponents of the American way of life.

These unselfish men who give leadership in scouting are performing an outstanding act of citizenship. Our nation owes them much.

Suggestion for rising young legislators: don't seek a name by proposing a new law. Instead, specialize in repealing old ones. Practically every state has on its books statutes which have no bearing on modern life. — Cuero, (Tex.) Record.

Opposition is proof that you are on the right track.

Radio and Television
SALES AND SERVICE

HAROLD PHINNEY
85 MAIN ST. (OPP. A & P) TEL. 1175



CURRAN & JOYCE COMPANY

— MANUFACTURERS —

SODA WATERS
and **GINGER ALES**

Dollar Days

OUTSTANDING SAVINGS ON ALL

BOY'S WEAR! 377 ESSEX ST. LAWRENCE

Friday
and
Saturday

Kap's

BOYS SHOP



TRICHINOSIS by Science Features

Modern kitchen and sanitary conditions have reached a new high in efficiency but that hasn't stopped the spread of the ancient disease of trichinosis—acquired by eating raw or poorly cooked pork.

The United States, the best fed country in the world, has highest rate of trichinosis according to the Public Health Service. Their survey showed that one in every six is affected in varying degrees.

The disease is carried by microscopic worms, called larvae, that are imbedded in the muscles of pigs. When the infected meat is eaten, the larvae are reproduced in the body and carried in the bloodstream to the muscles.

Eye infections characterized by puffing and secretion, fever, aching muscles and other symptoms occur a week after eating the infected pork. No definite cure is known for the disease, but cortisone and the new hydrocortisone drugs have been successful in remedying the painful effects.

Super-cortisone such as Cotril have cleared the eye infections faster than any other drug, according to Dr. E. H. Steffensen of the Henry Ford Hospital. The new drug is also available in liquid form for injection into sore areas.

Several Bequests In Woman's Will

Several bequests were made in the will of Jennie M. Hall of 43 High st., who died Jan. 16 at the home of her daughter in Pennsville, N.J., it was revealed when the will was filed last week in Probate court at Lawrence.

Real estate valued at \$15,000 and a personal estate of \$125 were left by the deceased. Helene F. King of Pennsville, N.J., a daughter was named executrix.

The following bequests were made: to Nellie Meehan of Worcester, \$200., to Mabel E. Marshall of Andover, \$100., to the Friendly Service committee of the Women's Union of the South church, Andover, \$50.

The remainder of the estate was left in three equal shares to her three daughters, Mrs. King, Frances M. Graham of Silver Springs, Md., and Ruth Graham of Wickliffe, O., who were also left household articles and jewelry.

NAMED CONSERVATRIX

Anna M. Greeley was appointed by Judge John A. Costello in Probate court at Salem last week as conservatrix of the property of Mrs. Jessie McIntosh of Andover. A bond of \$1000 was filed.

Established 1887
THE ANDOVER TOWNSMAN
Published Every Thursday
70 Main Street, Andover, Mass.
Entered as Second Class Matter at
The Andover Post Office
Price 5¢ per Copy \$2.50 per Year

Publisher Irving E. Rogers
Editor Frank J. A. Humphrey
Adv. Mgr. Raymond B. DeRuisseau
Ballardvale Ruth Green
Shawsheen Helen Caswell
West Parish Sarah Lewis

NATIONAL EDITORIAL ASSOCIATION
ACTIVE MEMBER

Down the Years with The Townsman

50 Years Ago — February 1904

A special electric which left the square at 8:30 a.m. yesterday conveyed a large delegation of Grangers to West Newbury to attend the Pomona Grange meeting there.

The academy student indicted for ringing a false alarm has been discharged in superior court, the district attorney declining to ask for a conviction and the jury returning a verdict of not guilty by order of the court.

A Lawrence-to-Andover electric just reached the railroad bridge on Main street last Saturday night when a fuse blew out. The airbrakes refused to work and the car rolled backwards down the hill at a high rate of speed, coming to a standstill near the Curran & Joyce estate. The car was crowded, many passengers were frightened, but with no other car in sight there was no danger of collision and a panic was averted.

A class in physical culture has been formed by a number of young ladies of the Free church. A physical culture class for women has been organized by the same teacher in the Grand Army hall.

Considerable anxiety has been felt on account of the number of scarlet fever cases among the children of the Vale. All cases so far have been light ones.

On the beach at Ormand, Fla., Jan. 27, W. K. Vanderbilt Jr., the New York millionaire auto enthusiast, drove his machine in an officially timed mile in 39 seconds, a new world's record.

The political pot is beginning to boil mildly, only one contest being on at present, that between S. H. Boutwell and W. S. Donald for selectman. The contest promises to be lively.

25 Years Ago — February 1929

The widening and rebuilding of North Main street, a matter that has been debated for the past 25 years, is expected to come up for action at the town meeting next month. The matter of a new junior high school also appears to be due for a hearing.

Kirk R. Batchelder of Lowell st., and Harry I. Emmons of York st., were injured in Lawrence last Tuesday when the auto in which they were riding was in collision with an electric car on Newbury street. Both were taken to the hospital and released after treatment. William H. Midgley of S. Main st., and Alfred Emmons of Methuen, who were also in the auto, were shaken up but unhurt.

Miss Mary Geagan of Ballardvale and Fred E. Cheever of Bancroft rd., will be candidates for re-election to the school board. Ernest A. Johnson of William st., will not seek re-election. H. Gilbert Francke of Main st., has taken out nomination papers for the office.

The police shelter in Shawsheen square was destroyed by fire early

Sunday morning. The blaze started from an oil burner. It was discovered by Officer John Deymond, who was on duty in the square. He threw the burning heater outside but because of the intense heat could not return to the shelter for his equipment. He and Officers Dailey and Walker lost equipment and clothing. Because

the alarm did not register the correct number at the fire station a delay was caused which allowed the oil from the heater to spatter the woodwork and make it an easy prey for the flames.

10 Years Ago — February 1944

The BPW will ask funds for a snow-sand loader at the town meeting and the selectmen will sponsor an article for a new 500-gallon pumper to replace the 30-year-old piece housed at the Vale fire station.

The selectmen will sponsor an article to allow the town to purchase the Shaw property, another authorizing them to rent it, and a third asking \$2500 for an engineering study to ascertain the best use of the land for town purposes.

The tin collection last Sunday netted eight tons.

Few contests loom in the town election. Candidates still have until tonight to file papers.

The resignation of Miss Mary Angus as a teacher in the local schools was accepted with regret by the school committee Tuesday evening. It was announced at the meeting that a budget of \$197,000 had been approved by the finance committee.

The salary question for town employees may become a town meeting free-for-all unless some definite policy is lined up. Two meetings have been held by town officials but the general feeling is that each department should handle its own problems.

Educator To Speak In Church Series

The main speaker at the second of the University of Life series which will be held Sunday at the Free church will be Dr. Edwin Prince Booth, who has been teaching at the Boston university School of Theology for 29 years.

The subject of his address is "The Christian Church and Civil Liberties."

Recently in an article about Dr. Booth and his great contribution to education and religion, the Christian Science Monitor said: "His work has not kept him within the walls of Boston university. His biography lectures have taken him to churches as far west as California."

Dr. Booth has written a number of books on religion but they are few in number in comparison to the men whom he has helped train for the Christian ministry.

THURSDAY - FRIDAY - SATURDAY
BIG SAVINGS LAMPS
ALL HAEGER WARE



Other Gift Items
Drastically Reduced

Andover Gift House

10-12 PARK STREET

TEL. 1822

WEDDING

McDUFFIE —

In the Rye P. Rye, N.Y., Saturday 10 o'clock, Miss E. Norden, daughter of Van Norden of the bride of Clifford Duffie, son of Mr. Dennett McDuffie. The Rev. S. Duffie officiated.

The bride wore a gown by her mother, I wore an Italian in a court train veil was caught by Brussels rose petals worn by her mother, with a tulle blossoms also worn. She carried a handkerchief with a cymbidium orchid.

Miss Margaret Rye, as maid of honor, carried yellow and carried yellow lips and violets.

bridesmaids, gown green chiffon, carried yellow daffodils were Mrs. Harry of Gorham, N.H., Mr. Jr., of Richmond, Pa.; Miss Duffie of Cambridge; and Miss Caw of Rye.

For her daughter Van Norden wore a soie gown, a navy and rose came from the groom's mother, wore a beige gown and red roses.

Dr. Frederick of Boston was the brother. The usher was Murray Howe, Jr., Selden, cousin of both of Andover, sons, Jr., John Philip Thomas Duffie and Neil McLean.

A small reception at the bride's home followed the wedding.

After a wedding will live in New York. The bride attended day school and was Oldfield school college. She attended Assemblies and in 1947. The bride graduated from Phillips serving with the Red Cross. She was a member of C.

STAHLER — WAKE

Miss Virginia R. Wake and Mrs. Dorothy became the bride of R. Stahler, 10 She 3 o'clock ceremony parsonage of the Rev. Frederic Duffie.

The bride wore a dress of ice blue hat and a white orchid. Paul Wake Jr., of the groom, wore a dress with black corsage of mixed flowers. Paul Wake Jr., the best man.

A reception in the parsonage followed with guests present from Middleton and Andover. Following a wedding at York City the couple left for the 7 Locke st.

The bride is a graduate of the high school and is in a business office.

WEDDINGS...

McDUFFIE - VAN NORDEN
 In the Rye Presbyterian church, Rye, N.Y., Saturday afternoon at 4 o'clock, Miss Elizabeth Ann Van Norden, daughter of Mrs. Max Langdon Van Norden and the late Mr. Van Norden of Rye, N.Y., became the bride of Charles Howard McDuffie, son of Mr. and Mrs. Charles Dennett McDuffie of School st. The Rev. S. Carson Wasson officiated.

The bride who was given in marriage by her mother and escorted by her brother, Pierre Van Norden, wore an Italian satin gown ending in a court train. Her tulle chapel veil was caught to a crown of Brussels rose point lace previously worn by her grandmother and mother, with a trimming of orange blossoms also worn by her mother. She carried an heirloom rose point handkerchief with her bouquet of cymbidium orchids and stephanotis.

Miss Margaret Joan Hodgman of Rye, as maid of honor, wore a ballerina-length yellow chiffon gown and carried yellow hyacinths, tulips and violet anemones. The bridesmaids, gowned alike in spring green chiffon, carried bouquets of yellow daffidols and violets. They were Mrs. Harry Atwood Bishop Jr., of Gorham, N.H.; Mrs. Henry Taylor Jr., of Richmond, Va.; Mrs. James Ford Monroe, 2nd, of Abington, Pa.; Miss Sarah Wilson McDuffie of Cambridge, sister of the bridegroom; and Miss Mary-Adams Morris and Miss Kirby Custis McCaw of Rye.

For her daughter's wedding Mrs. Van Norden wore a navy peau de soie gown, a navy blue velvet hat, and rose camelias. The bridegroom's mother, Mrs. McDuffie, wore a beige gown and corsage of red roses.

Dr. Frederick Clement McDuffie of Boston was best man for his brother. The ushers were: Archibald Murray Howe, Jr., and George Lord Selden, cousin of the bridegroom, both of Andover, Harry Irving Emmons, Jr., John Hemphill, Jr., and Philip Thomas Dwight of New York, and Neil McLean Holt of Yonkers.

A small reception was held for the bridal party and the immediate families in the home of the bride's mother.

After a wedding trip the couple will live in New York.

The bride attended Rye Country day school and was graduated from Oldfield school and Sweet Briar college. She attended the Junior Assemblies and made her debut in 1947. The bridegroom was graduated from Phillips academy and after serving with the army was graduated from Yale college, where he was a member of Chi Psi.

STAHLER - WAKE

Miss Virginia Ruth Wake, daughter of Paul B. Wake Sr., of Middleton and Mrs. Dorothy Wake of Salem, became the bride of Kenneth M. Stahler, son of Mr. and Mrs. Frank R. Stahler, 10 Sherbourne st., at a 3 o'clock ceremony Saturday in the parsonage of the South church. The Rev. Frederick B. Noss officiated.

The bride wore a street length dress of ice blue, a white velvet hat and a white orchid corsage. Mrs. Paul Wake Jr., of Danvers, as matron of honor, wore a dusty pink dress with black accessories and a corsage of mixed flowers.

Paul Wake Jr., of Danvers, was the best man.

A reception in the South church parsonage followed the ceremony with guests present from Danvers, Middleton and Andover.

Following a wedding trip to New York City the couple will reside at 7 Locke st.

The bride is a graduate of Danvers high school and was employed in a business office in Danvers.

The bridegroom was recently discharged from the army after serving three years, 26 months of which was spent in Europe. He is associated with his father in business.

DAVIDSON - LINDAHL

At a 4:30 o'clock candlelight ceremony Saturday in the Church of Christ, Dartmouth college, Hanover, N.H., Miss Martia Alice Lindahl, daughter of Prof. and Mrs. Martin L. Lindahl, 12 Woodrow rd., Hanover, N.H., became the bride of Leon John Davidson, son of Mr. and Mrs. Leon Davidson of Lowell st. Frank McCarthy was the soloist. The altar was arranged with white snapdragons, gladioli and chrysanthemums.

Given in marriage by her father the bride wore a gown of ivory satin fashioned with a low neckline outlined in lace and seed pearls, and a bouffant skirt which ended in a chapel length sweep. Her fingertip veil of illusion was attached to a Juliet cap of matching lace and she carried a small bouquet of white hyacinths centered with an orchid.

The bridal attendants included Miss Elizabeth Lindahl of Hanover, as maid of honor, and the Misses Janet Waggoner, Irvington, N.Y., Rosemary Davidson of Andover, Jane Hastie of Hanover, N.H., Nancy Keefe of Norwell, Dale Blandin and Mrs. John McIntyre of Hanover, N.H., were the bridesmaids. All the attendants wore ballerina length gowns of tulle over taffeta, the maid of honor in pink and the bridesmaids in rose. Colonial bouquets were carried by all.

Charles Davidson of Andover served as best man for his brother and the ushers were: Gerald, Ronald and Branton Henderson of Philadelphia, Pa., John Sutherland of New York City, Laurence Hollman of Cambridge, Frederick Flather III, and Bernard McParland of Andover.

A reception in the Hanover Inn followed the ceremony after which the couple left on a wedding trip to Canada.

The bride attended Carleton college, Northfield, Minn., and was graduated from the University of Vermont in 1952. She is a secretary at the Sheraton Plaza hotel, Boston. Mr. Davidson is a graduate of Phillips academy and Harvard college in 1953. He is a member of the Hasty Pudding club and a past president of the Pi Eta club. He holds a commission in the air force and will report to Sampson air base in February.

TRY A TOWNSMAN WANT AD - CALL 1943



Mrs. Leon John Davidson (David Pierce Studio)

Philadelphia, Pa., John Sutherland of New York City, Laurence Hollman of Cambridge, Frederick Flather III, and Bernard McParland of Andover.

A reception in the Hanover Inn followed the ceremony after which the couple left on a wedding trip to Canada.

The bride attended Carleton college, Northfield, Minn., and was graduated from the University of Vermont in 1952. She is a secretary at the Sheraton Plaza hotel, Boston. Mr. Davidson is a graduate of Phillips academy and Harvard college in 1953. He is a member of the Hasty Pudding club and a past president of the Pi Eta club. He holds a commission in the air force and will report to Sampson air base in February.

TRY A TOWNSMAN WANT AD - CALL 1943

A man with a fiery temper gets into many heated arguments.

Argument settles but one thing—and that is it settles nothing.



Twin
Dollar Days
 Friday and Saturday

Whopping Values

FREE INCOMING BUSES
 FRIDAY 9 to 11 A.M.



FRIDAY & SATURDAY

ARE

LAWRENCE

DOLLAR DAYS

- For Bona-Fide BARGAINS In All Stores
 Displaying The Official Dollar Days
 Banners. Your Savings Will Make The
 Trip MORE THAN WORTH-WHILE!

FREE BUS TRANSPORTATION
 TO LAWRENCE FRIDAY
 9 to 11 A. M.

RETAIL TRADE BOARD - GREATER LAWRENCE CHAMBER OF COMMERCE

Discovery of new sources of revenue is the only way most politicians know how to lighten the tax burden.

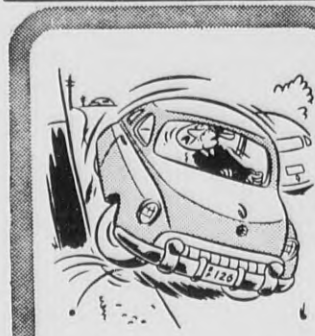

MISS THAT POLE?

You may not always be able to avoid a costly accident. If your car injures or kills someone, will you have the protection of dependable Automobile Insurance?

DOHERTY
Insurance
AGENCY

MAIN ST. TEL. 260

AT THE CHURCHES

Andover Baptist Church

REV. ROY E. NELSON JR., Minister
FRIDAY: 8 p.m. Monthly meeting of the Philathea class, Mrs. Clinton H. Stevens, president, in charge. Every member is requested to be present and to bring a dish towel for the church kitchen. A Valentine party has been planned at which time Valentines are to be exchanged.

SUNDAY: 9:30 a.m. Church school. 10:15 a.m. Carillons and chimes. 10:45 a.m. Morning service of worship with the observance of the Lord's Supper. Communion meditation by the pastor, Rev. Roy E. Nelson Jr., on the subject: "His Hand Was Good Upon Me." Adult choir will sing. Nursery for the small children.

MONDAY: 8 p.m. Monthly meeting of the Friendly circle. A valentine party will be enjoyed. Each member is asked to bring a valentine.

TUESDAY: 8 p.m. The Deaconate board will meet in the church parlor. The pastor urgently re-

quests that every member be present.
THURSDAY: 2 p.m. Woman's Union meeting. 7:30 p.m. Adult choir rehearsal.

FRIDAY: 7:30 p.m. Baptist Youth Fellowship valentine party at the home of Miss Bonita Hajjar, 133 Elm st.

Free Church

Rev. Levering Reynolds Jr., Th. D. Pastor

FRIDAY: 7 p.m. Scout Troop 72 and Explorer Post 72.

SUNDAY: 9:15 a.m. Senior classes in the church school. 10 a.m. Junior classes in the church school and the nursery class for younger children. 10 a.m. Morning worship with sermon by the pastor. 2:30 p.m. The Pilgrim Fellowship will attend the rehearsal in Cochran chapel. 5:30 p.m. The second session of the University of Life, in this church. The chapel speaker will be Dr. Edwin P. Booth, professor of historical theology in Boston University School of Theology.

TUESDAY: 7 p.m. Pack meeting, Cub Pack 72. The TV skit program will be held at this meeting.

THURSDAY: 10 a.m. Sewing circle of the Women's Union. 3:25 p.m. Junior choir rehearsal. 6 p.m. Choir of Youth rehearsal. 7:30 p.m. Senior choir rehearsal.

NOTES: On Saturday evenings, Feb. 13, at 6 p.m., the annual scouting father and son banquet will be held in the lower parish hall. Tickets may be obtained from den mothers, Cubmaster and Explorer Advisor Robert Domingue, or Scoutmaster John B. Souter, Jr.

South Church

REV. FREDERICK B. NOSS, Pastor

FRIDAY: 3:30 p.m. Children's music group. 7:30 p.m. Troop 73, boy scouts.

SUNDAY: 9:30 a.m. Church school for fourth through twelfth grades. 10:45 a.m. Morning worship. 10:45 a.m. Kindergarten, nursery school, grades 1, 2 and 3.

MONDAY: 7 p.m. The Courteous Circle of The King's Daughters. Devotions in charge of Mrs. Bond. A silent auction will be held.

TUESDAY: 8 p.m. Ping Pong club.

WEDNESDAY: 7:30 p.m. South church choir rehearsal.

THURSDAY: 3:30 p.m. Junior choir rehearsal. 7:30 p.m. Committee meeting for the cub scouts.

Union Congregational Church

REV. RAYMOND B. WILBUR, Minister

SATURDAY: 9 a.m. Basketball practice.

SUNDAY: 9:30 a.m. Church school. 10:45 a.m. Morning worship service and Communion. Sermon: "What Seek Ye?" 4 p.m. Philosebeans - all young people between the ages of 10 and 14 are invited to join this group. 5 p.m. Young people desiring to go to the University of Life meet at the parsonage.

TUESDAY: 3:30 p.m. Junior choir rehearsal. 6:30 p.m. Fellowship choir rehearsal. 7:30 p.m. Stitch and Giggle club.

The North Parish Church

(Unitarian) - North Andover

REV. E. A. BROWN JR., Minister

FRIDAY: 7 p.m. Boy scouts.
SUNDAY: 9:45 a.m. Church school. 9:45 a.m. Kindergarten. 11 a.m. Morning Service. The Rev. Philip R. Giles, guest preacher. 11 a.m. Nursery class. 5 p.m. Youth Fellowship.

MONDAY: 3 p.m. Girl scouts. 7:45 p.m. United Churchmen's Fellowship.

TUESDAY: 2 p.m. Afternoon Alliance.

THURSDAY: 3 p.m. Junior choir.

Methodist Church

ANTHONY PERRINO, Pastor

SATURDAY: 9 a.m. Junior M.Y.F. will meet at the parsonage and go in a group with Mrs. Perrino to roller skate in Lowell.

SUNDAY: 9:30 a.m. Sunday school convenes. 10:45 a.m. Sunday morning worship service. Sermon: "I and Thou". 3:30 p.m. The Junior M.Y.F. will meet in the vestry.

Christ Church

REV. JOHN S. MOSES, Rector

SUNDAY: 8 a.m. Holy Communion. 9:30 a.m. Sunday school. 11 a.m. Holy Communion and sermon. 11 a.m. Nursery class. 4 p.m. Confirmation class (adults).

MONDAY: 6:30 p.m. Thrift shop dinner. 12:30 p.m. Weekday religious education.

TUESDAY: 2:30 p.m. Confirmation class. 8 p.m. Vestry meeting.

THURSDAY: 10 a.m. Holy Communion. 6:30 p.m. Choir rehearsal.

West Parish Church

SUNDAY: 10:30 a.m. Children's service. Classes for nursery and young people of high school age. 11 a.m. Morning service of worship. Classes for grades one through six.

TUESDAY: 3 p.m. Children's choir rehearsal.

WEDNESDAY: 7 p.m. All-Girl's choir rehearsal.

THURSDAY: 8 p.m. Junior Woman's Union.

Christian Science Society

(6 Locke Street)

SUNDAY: 9:30 a.m. Sunday school. 11 a.m. Church service. Subject of lesson sermon: "Spirit".

Reading room 66 Main street, corner of Chestnut street, 12 noon to 4 p.m., Monday through Friday.

Cochran Chapel

REV. A. GRAHAM EALDWIN, Minister

SUNDAY: 5:15 p.m. Vesper service of worship. Speaker, Dr. Edwin P. Booth of Boston university.

St. Augustine's Church

REV. P. J. CAMPBELL, Pastor

SATURDAY: Confessions 4 to 5:30 p.m. and 7:30 to 9 p.m.

SUNDAY: Masses 6:30, 8, 9, 10 and 11:30 a.m. Benediction after 11:30 Mass. Baptisms at 3 p.m.

St. Joseph's Church

(Ballardvale)

SUNDAY: Mass at 9 a.m. Confessions are heard before Mass.

State To Improve Parker Forest Site

At the Harold Parker state forest \$29,000 will be spent by the state this year from the \$462,500 which has been allotted for the beautification and improvement of the state's forest and parks, Arthur T. Lyman, commissioner of natural resources has announced.

The money to be spent on the local area will be for rest rooms, 50 fireplaces, drinking fountains, beach improvements and additional parking places at Stearns pond.

Subscribe to the TOWNSMAN

USEFUL CARS... You'll Appreciate!

1951 MERCURY Convertible. Choose from two. Fully equipped. Light Green or Black.

1950 CADILLAC Deauville Coupe. Radio, Heater, Hydramatic. Deep Green.

1950 MERCURY Club Coupe. Radio, heater, tubeless, white sidewall tires. Black.

1950 BUICK SPECIAL 4-Door Sedan. Radio, heater, standard transmission. Green.

"KEN" CROMPTON'S

ARLINGTON MOTORS, INC.

YOUR LINCOLN AND MERCURY DEALER
622 BROADWAY LAWRENCE TEL. 37188

P. H. Sport

Punchard 52, Saugus 44

Punchard had to stage a second period rally to keep up with Saugus on the local court last Friday night but after pulling up within one point of the visitors by the end of the second half the Blue Devils continued to click and went on to win 52-44.

Paul Whitley, down with a cold, did not start the game but when the home team was trailing seven points midway through the second half he entered the contest and got the Blue Devils rolling.

Playing right forward Capt. Billy Stack rung up 22 points while Dyer scored 12 and Whitley 10. Diamond with 23 was high scorer for Saugus.

The Punchard JV team romped away from their rivals 39-18.

The summary:

| PUNCHARD (52) | | SAUGUS (44) | |
|---------------|----------|-------------|---------|
| G | F | G | F |
| Dwyer lf | 6 0 12 | Lawrence lf | 6 0 12 |
| Stack rf | 10 2 22 | Piwowski rf | 1 1 1 |
| Pigeon c | 0 0 0 | Diamond c | 11 12 |
| Whitley | 3 4 10 | Morgan lg | 1 0 1 |
| Lefebvre lg | 1 2 4 | MacNeill rg | 8 3 11 |
| Yancy rg | 1 2 4 | Deschier | 0 1 1 |
| Totals | 21 10 52 | Totals | 18 8 44 |

Score by periods: 1 2 3 4 7
Punchard 14 11 14 13-47
Saugus 14 12 6 12-44

Referee—Boyle and Murphy. Time—Four 8s.

| Punchard JV (39) | | Saugus JV (18) | |
|------------------|---------|----------------|---------|
| G | F | G | F |
| O'Connor lf | 1 1 3 | Krom lf | 0 0 0 |
| Gallant | 0 0 0 | Keefe rf | 2 2 4 |
| Belka | 0 0 0 | Galente | 0 2 2 |
| Poigreen | 0 0 0 | Wolver | 0 1 1 |
| Vickers rf | 6 2 14 | Tracy c | 2 0 4 |
| Durant | 0 0 0 | Wade lg | 0 1 1 |
| Emmons | 1 0 2 | Rice rg | 1 1 1 |
| Richardson | 0 0 0 | Termini | 0 1 1 |
| Thompson lg | 2 1 5 | | |
| Fisher | 2 0 4 | | |
| Nichol | 0 0 0 | | |
| Wadman rg | 2 2 6 | | |
| Totals | 16 7 39 | Totals | 8 11 18 |

Score by periods: 1 2 3 4 7
Punchard 10 9 13 7-39
Saugus 5 5 2 6-18

Referee—Davey. Time—Four 7s.

Heads Area Drive In TV Campaign

Mrs. Robert Saltonstall Jr., of North Andover, is chairman for the northeastern section of Massachusetts for the forthcoming campaign to raise operating funds for Channel 2, the non-commercial educational television station which is expected to be on the air next fall. Dr. Claude M. Fuess, headmaster emeritus of Phillips academy, is general chairman.

The campaign, to be launched soon, will seek a total goal of \$1,053,000 of which \$600,000 is mostly for construction purposes already in hand.

Andover is in the campaign area of which Mrs. Saltonstall is chairman.

SHAWSHEEN FROZEN FOOD CENTER INC.

Quality Meats At
Sound Prices
Best Grade
Frozen Foods

16 TANTALLON ROAD
ANDOVER 2324

DOLLAR DAYS



See Them
In Our
Windows

SAVE
UP TO
\$70⁰⁰

| Make and Sizes | Was | NOW |
|---------------------------------------|----------|---------------------|
| DuMont 21" Console | \$399.95 | \$329 ⁹⁵ |
| DuMont 3-Way Combination | | \$199 ⁹⁵ |
| General Electric 17" Console | \$299.95 | \$229 ⁹⁵ |
| General Electric 21" Console | \$369.95 | \$299 ⁹⁵ |
| Motorola 17" Table Model | \$229.95 | \$199 ⁹⁵ |
| Motorola 17" Console | \$299.95 | \$229 ⁹⁵ |

EASY TERMS—Price Includes Tax and Warranty

LEONE'S
LARGEST APPLIANCE STORE IN LAWRENCE

430 Essex Street

Lawrence

Tel. 6197

Fifth and s
PTA meeting
shaw, Constan
Cynthia Thor
Rees, Ann H
Walsh, Betty

PUN

Class Rings

Several member class met recent class ring. Many were submitted and the group oval shape ring consisted of, Joan Regina Burrows, Marianne Garabed, Robert Le, Richard Lumened, Ruth Santuccio, Philip Spinney, ney.

Honor Society

The National H chard met Monday students to meet visitors to select the society. They in March. The resen were: Carol nor Doucette, and Ann Sughruce visitors are Miss vens, Miss E. M. G. Arthur Danfor ciety is open of the junior and se

Year Book

The Senior c work on its y committees have the work has very rapidly. E Gail Thompson as co-editors. T the year book a Barker, chairman Joan Robinson, Carol DesRoche, Roches, Maureen ley, James Adar son, and Gerald Ann Smith, chair Westfall, Paula Barron, Sylvia Maise; photograp chairman; Patric Doucette, John C

Sport

August 44
to stage a second
keep up with Sas
court last Friday
pulling up within
visitors by the
and half the Blue
to click and we

down with a cold,
the game but when
was trailing seven
through the second
the contest and
hills rolling.
t forward Capt.
ne up 22 points
ed 12 and Whitley
with 23 was high
s.
JV team romped
rivals 39-18.

SADGERS (44)

| | |
|---------------|--------|
| 1 Lawrence lf | 0 2 1 |
| 2 Piwowski rf | 1 1 3 |
| 3 Diamond c | 11 2 3 |
| 4 Morgan lf | 1 0 2 |
| 5 MacNeill rg | 3 3 11 |
| 6 Desehier | 0 1 1 |

2 15 34 7

1 2 3 4 7
... 14 11 14 13-31
... 14 12 6 12-44

and Murphy. Time -

Saugus JV (18)

| | |
|-------------|-------|
| 3 Krom lf | 0 0 0 |
| 0 Keete rf | 2 2 4 |
| 0 Gaiante c | 0 2 1 |
| 0 Wyley | 0 1 1 |
| 14 Leahy e | 2 0 4 |
| 0 Wade lg | 0 1 1 |
| 2 Rice rg | 1 1 1 |
| 0 Termini | 0 1 1 |

39 Totals 5 11

1 2 3 4 7
... 10 9 13 7-39
... 5 5 2 6-11

Time—Four 7a.

Area Drive Campaign

Saltonstall Jr., chairman for the
ction of Massachusetts
rtcoming campaign
g funds for Channe
mercial education
n which is expected
air next fall. Dr.
s, headmaster emer
academy, is gener
n, to be launched
k a total goal of
which \$600,000
struction purposes.

the campaign area
altonstall is chair

SHAWSHEN FOOD CENTER INC.

Meats
Prices
Grade
n Foods

LLON ROAD
VER 2324

preciate!

Heater,

r, tube-

, heater,

INC.
EALER
L. 37188



Fifth and sixth grade Campfire girls of the Shawsheen school who participated in the recent PTA meeting when parents visited the classrooms. The trio in front center are, Shirley Warshaw, Constance Becotte and Susan Miller; kneeling directly behind them are, Louanne King, Cynthia Thompson, Kathy O'Shea and Charlene Benedetti; standing, Carol Reilly, Lorraine Rees, Ann Henrich, Carol Andrew, Meredith Manning, Susan Goldman, Peggy Jo Lancy, Ann Walsh, Betty Michelski and Cynthia Turton. (Look Photo)

PUNCHARD HIGH
By JOYCE M. WILLIAMS

Class Rings

Several members of the Junior class met recently to choose a class ring. Many different styles were submitted by local jewelers and the group decided upon an oval shape ring. The committee consisted of, Joan Silva, chairman; Regina Burrows, Ernest Clegg, Marianne Garabedian, George Henrick, Robert Leete, Anne Lord, Richard Lumenello, Glen Peatman, Ruth Santuccio, Valerie Shaw, Philip Spinney and Marcia Tangney.

Honor Society

The National Honor Society of Punchard met Monday to choose four students to meet with faculty advisors to select candidates for the society. They will be initiated in March. The representatives chosen were: Carol DesRoches, Eleanor Doucette, Gladys Thomson, and Ann Sughrue. The faculty advisors are Miss Beatrice L. Stevens, Miss E. Marjorie Smith, and G. Arthur Danforth. The Honor Society is open only to members of the junior and senior classes.

Year Book

The Senior class has started work on its yearbook. Various committees have been chosen and the work has been progressing very rapidly. Batsy Sparks and Gail Thompson have been chosen as co-editors. The committees for the year book are: Literary, Jane Barker, chairman; Joyce Williams, Joan Robinson, Dorcas Johnston, Carol DesRoches, Rhoda DesRoches, Maureen Darby, Paul Whitley, James Adams, Charles Simpson, and Geraldine Gordon; art, Ann Smith, chairman; Lesley Jane Westfall, Paula Williams, Shirley Barron, Sylvia Zalla, and Ronald Muise; photography, Ann Sughrue, chairman; Patricia Dolan, Eleanor Doucette, John Carver, Edith Doh-

Senior Dance

The Senior class of Punchard will hold a Valentine dance Friday, Feb. 12. Many unusual events have been planned for the occasion and a King and Queen of Hearts will be selected from those attending. The committee planning the dance is; Raymond Yancy, chairman; James Floyd, Ann Smith, Dorcas Johnston, George Adams, Marilyn Decker, Joan Keith, Gladys Thomson, James Sparks, Judith Cooke, Barbara Wright, Maureen Darby, Robert Hesse and Ann Sughrue.

Junior High Play

The annual production of the Junior high school will be presented at 8 p.m., Friday, Feb. 19 in the Memorial auditorium. The play, entitled "The Little Dog Laughed"

by Vera and Ken Tarpley, is a comedy of a college psychology student's analysis of her family. The cast consists of members of all grades of the Junior high. The play is under the direction of Miss Ansi Angelo.

Notes

Report cards were distributed in all home rooms of the Junior and Senior high school Wednesday.

Free Church Notes

The midwinter meeting of the Andover Association Pilgrim Fellowship will be held at 7:30 p.m., Saturday, in the Lawrence Street Congregational church, Lawrence.

At 3 p.m., Sunday, a scouting service will be held at the First Calvary Baptist church, Lawrence. Dr. Reynolds will preach at this service.

Subscribe to the TOWNSMAN

THE POSTMAN

... stops at your home 300 times a year. What if he gets hurt on your premises?

... You need our inexpensive Personal Liability insurance!

... Just call -

SMART & FLAGG INC
The Insurance Office
Bank Bldg. Andover 870

GEO. W. HORNE CO.
LAWRENCE, MASS.

TAR AND GRAVEL ROOFING SHEET METAL WORK
SPECIALIZING IN ASPHALT SHINGLING
Telephone 7339 Established 1854

Youth Center

The sewing class under the direction of Mrs. Henry Boucher has started a new project. It will make roller skating skirts and costumes to take care of the increasing number of entrants in the Primary, Junior and Intermediate girls' classes.

The increasing number of parents who "Stop in" at the Youth Center is very encouraging. Director Donald D. Dunn reports that in many cases after parents have toured the center they express amazement that there is so much available to the youngsters of the town that they never knew existed.

The sewing class is open to all girls of the center where they may receive instruction in crocheting, knitting, weaving, braiding and sewing.

Monday evenings from 6 to 9 o'clock are Girls' nights when all facilities of the center are turned over to the girls under the direction of Miss Joan Rizzo. Business girls and working girls may join these classes by calling or visiting the center, 10 Brook st.

Pacific Promotes Robert C. Wilkie

Robert C. Wilkie of S. Main st., inventor of the Pacific converter and other textile machines and processes, has been promoted to the post of assistant director of research of Pacific Mills Craft Fabric division (worsted operations), according to Harold W. Leitch, director of research.

Advancement of Mr. Wilkie marks the continued expansion of Pacific's research covering wool and other fibers. In addition to the mill in Lawrence the division operates mills in Virginia and North Carolina.

Mr. Wilkie was graduated from the Lowell Technological Institute and came to the Pacific Mills in 1937. His wife is the former Barbara Dalton of Newton. They have two sons and a daughter.

REAL ESTATE
BRADLEY
Andover 654-W - Law. 7029

END GARBAGE NUISANCE

WITH
HOLLINATOR
the indoor incinerator with Magic Flue



Now, for the first time, there's a clean, odorless, low-cost way of solving your trash and garbage disposal problem! It's HOLLINATOR—the Magic Flue incinerator that turns trash and garbage to ashes—in minutes!

All the trash and garbage burn themselves, so Hollinator doesn't cost you a penny to operate! It's the cheapest, cleanest, best way of ridding yourself of the trash and garbage nuisance—forever!



The Magic Flue is the secret of Hollinator's cost-free operation. It's true incineration—with high intensity combustion using pre-heated direct draft. At the touch of a match, everything burns to dry ash—in minutes. The Magic Flue is patented—you can get it only in Hollinator!

\$149⁵⁰ EASY TERMS

Hart Electric Co.
50 SOUTH BROADWAY LAWRENCE TEL. 30721

1954 Town Warrant Requests Sum Of \$1,772,379

(Continued from Page One)

the fire department. They were eligible for appointment but were in the armed services when vacancies occurred, thus losing their chances for appointment. The sums asked is to compensate them for what they lost up to the time they were appointed.

Articles 1, 2 and 4 call for the annual election and establishment of the salaries of town officials. Article 5 is to determine the appropriations for town departments. The other articles, in condensed form,



See, hear and play the latest models now on display in our store. They are moderately priced and fully guaranteed.

KNUEPFER & DIMMOCK

286 ESSEX ST., LAWRENCE
OPP. EAGLE-TRIBUNE

are:

3. To grant \$5 a week salary raise to fulltime employees of the BPW.

6. To rescind action of special town meeting creating rent control board.

7. To amend zoning laws to provide larger house lots in single residence districts.

8. To appoint a committee to study zoning problems and appropriate \$2500 for study.

9. To change zoning laws regarding removal of loam, gravel, etc., for sale except by permit from board of appeals.

10. To establish planning board under Chap. 41, General Laws, with present members to serve on new board.

11. To accept about 12.21 acres of land on Red Spring road from Helen E. Hardy.

12. To pay Henry L. Hilton \$342 and George C. Williams \$333 under Chap. 203 of Acts of 1947.

13. To appoint a town office building committee and make \$2500 available for preliminary plans and estimates of new town office building.

14. To appropriate \$1350 for two new autos for the police department.

15. To appropriate \$5063.40 to be spent with unexpended balance of \$3936.60 of 1953 appropriation for traffic booth and lights in Elm square.

16. To accept Chap. 85 of General Laws relative to registration of bicycles and appropriate \$100 to initiate registration service.

17. To appropriate \$8300 for fire department ambulance.

18. To appropriate a sum of money for Chap. 90 highway maintenance.

19. To appropriate \$20,000 for extending and improving town water system.

20. To authorize BPW to repair and build sidewalks and to appropriate \$5000 for work.

21. To appropriate \$750 to renew and adjust sewer and waterstructure in way of proposed highway reconstruction on Main street, between Dwight and Wheeler streets.

22. To appropriate or transfer from available funds \$80,000 for Ballardvale sewerage system, to be used with sum set up in 1953 town meeting.

23. To appropriate \$15,000 for relief sewers in Chestnut, Elm and Essex streets and other necessary locations.

24. To appropriate \$5000 for acquisition of land on watershed of Haggitt's pond and Fish brook to protect water supply and increase storage.

25. To appropriate \$4500 to reconstruct Elm street from present end of state highway near Washington avenue southerly toward Elm square.

26. To appropriate \$1000 for baseball diamonds at the playstead.

27. To appropriate \$1500 for widening and improving Beacon street and Chandler road near their intersection.

28. To appropriate \$2000 for a storm drainage system near Nos. 5 and 7 Hidden road.

29. To appropriate \$825 for widening easterly side of Riverina road from Haverhill street northerly about 350 feet.

30. To appropriate \$2500 for widening and improving a portion of Summer street from a point near No. 127 easterly about 750 feet.

31. To appropriate \$10,000 for necessary drainage, grading, etc., of recently enlarged playstead area.

32. To appropriate \$9450 to enclose Rogers brook in an enclosed culvert from rear of Coleman's property westerly about 315 feet.

33. To acquire parcel of land to extend protective fencing along Shawsheen river, and to appropriate \$25 therefor.

34. To extend water main on Brundrett avenue northerly about 1600 feet to property of Jacob Shlakis, and appropriate \$6400 therefor.

35. To extend water main on Brundrett avenue southerly about 800 feet to property of Wilfred J. Robidoux, and appropriate \$3200 therefor.

36. To install 8-inch sewer main in westerly side of Elm street from Westwind road northeasterly about 1050 feet to a point near 172 Elm street and appropriate \$5250 therefor.

37. To extend sewer in Sutherland street from existing end northeasterly about 255 feet to a point near No. 29 and appropriate \$1150 therefor.

38. To construct a sidewalk on easterly side of Burnham road, from High street northerly about 900 feet, to remove trees, etc., and appropriate \$5014 therefor.

39. To appropriate \$312 for the purchase of a 20-inch chain saw for tree department.

40. To appropriate \$2250 to purchase new tractor and roadside mower for use in tree department.

41. To authorize the school committee to continue to maintain state-aided vocational education, and appropriate \$1755 therefor.

42. To appropriate \$15,000 for further study of needs and the prepa-

ration of preliminary plans to meet requirements of expanding junior and senior high schools, and to appoint a building committee.

43. To accept Chap. 387 of the Acts of 1953 authorizing town to grant annuities and to increase certain retirement allowances, pensions and annuities of certain officials and employees or to their surviving spouses or children, upon recommendation of the selectmen.

44. To appropriate \$600 to resurface portion of Central playground for year-round recreational purposes, to be spent in conjunction with \$2300 appropriated in 1950.

45. To appropriate \$2500 to repair Community room, stairways, etc., in Ballardvale.

46. To appropriate \$5000 to install and equip regulation Little League baseball diamond and put into condition the present standard-size diamond and field on the Andover-Woburn street playground in Ballardvale.

47. To accept as public ways: Alden road, from Porter road to Nutmeg road; Lantern road, from Hidden road to Alden road; Nutmeg road, from Sunset Rock road to Alden road.

48. To accept as a public way and name Cassimere street.

49. To accept as a public way: (1) remaining portion of Forbes lane; and (2) a portion of Karlton circle.

50. To accept an extension of Henderson avenue from present terminus northerly and westerly to Lupine road, a distance of about 416 feet.

51. To accept as a public way and name Juniper road.

52. To accept as a public way and name Linwood street.

53. To accept as a public way and name Lockway road.

54. To accept as public way and name Shirley road.

55. To accept an extension of Sutherland street, from present terminus northwesterly about 505 feet.

56. To accept as a public way and name Theodore avenue.

57. To accept \$2703 received in 1953 for perpetual care of lots in Spring Grove cemetery.

58. To authorize the treasurer to borrow money after Jan. 1, 1954 in anticipation of revenue for year beginning Jan. 1, 1954.

59. To authorize treasurer to borrow money after Jan. 1, 1955 in anticipation of revenue for financial year beginning Jan. 1, 1955.

60. To appropriate \$1500 to move granite watering trough from corner of Poor and Lowell streets to a site in the William M. Wood Memorial park.

61. To prohibit hunting in town except by permission by chief of police and property owners.

62. To transfer \$20,000 for Overlay Reserve to Reserve fund.

63. To permit assessors to use \$60,000 free cash to reduce the 1954 tax rate and to offset appropriations for capital outlay voted at the 1954 town meeting.

Protest Garbage Disposal On Roads

As the result of many complaints, police are going to vigorously prosecute offenders who throw garbage on the highways or on private property without permission.

If a motor vehicle is involved in the case it may result in the offender having his license suspended for 30 days along with the fine that is imposed for such violation.

The law says that "whoever, in disposing of garbage, bottles or rubbish on a public highway or within 20 yards thereof, or upon private property, without permission, commits a nuisance thereby, shall be punished by a fine of not more than \$50. If a motor vehicle is used in committing such nuisance a conviction under this section shall forthwith be reported by the court to the registrar of motor vehicles, and the registrar may suspend the license of the operator of such vehicle for not more than 30 days, and if it appears from the records of the registrar of motor vehicles that the person so convicted is the owner of the motor vehicle so used, the registrar may suspend the certificate of registration of said vehicle for 30 days."

COURTEOUS CIRCLE

Courteous Circle of The King's Daughters will meet Monday, Feb. 8 at 7 p.m., for a business session. Members are asked to bring gifts for a silent auction.

64. To determine disposition of unexpended appropriations and free cash in the treasury.

65. To act upon report of the town officers.

66. To transact any other business that may legally come before the meeting.

Planting Seed Flats

Now - Or Later

USE

TERRA-LITE

VERMICULITE

Plant Aid

Used in flats, it promotes the growth of strong, healthy seedlings for the home gardener . . . the greenhouse . . . the farmer.

- NO WEEDS
- PREVENTS DAMPING OFF
- EXCELLENT GERMINATION
- BETTER ROOT GROWTH

It's inexpensive, too! Packages from 45¢ to the largest greenhouse and farm sizes.

ANDOVER DELIVERIES DAILY

BRUCKMANN'S

GRAIN - HARDWARE - PAINT

158 So. Broadway Tel. 4105
Lawrence-Plenty of Parking Space

A FRIENDLY WELCOME AWAITS YOU
AT THE
ANDOVER BAPTIST CHURCH
Essex and Central Streets
SUNDAY AT 10:45 A.M.
Bible-centered Message by the Pastor
"HIS HAND WAS GOOD UPON ME"
Rev. Roy E. Nelson, Jr., Pastor
ACCEPT THE INVITATION OF THE CARILLONS AND CHIMES
Church School at 9:30 A.M.

Continuing Our Great
STOCK - REDUCTION

Sale

SAVE

$\frac{1}{4}$ - $\frac{1}{3}$ - $\frac{1}{2}$

On SHOES For Men, Women & Children
Also On Furnishings For Men & Boys

REINHOLD'S

13 MAIN STREET

QUALITY CLEANING, PRESSING

AND EXPERT TAILORING OUR SPECIALTY

On the Campus of Phillips Academy

Andover Inn
A "Treadway Inn"

Daily Luncheons 12 to 2 Dinner 6 to 7:30
Sunday Dinner 12:30 to 2:30
BUFFET SUPPER SUNDAY NIGHTS

WEDDING RECEPTIONS BRIDGE LUNCHEONS BANQUETS
Tel. 903 Edward Romeo, Manager • Andover, Mass.

GIFT SHOP OPEN 12 to 8 DAILY

Some of the 1 sponsored by the paign. Photo, to ferring bundles

OBITUARY

MRS. ALBERT E. FISCHER
Mrs. Augusta J. Fischer, wife of Albert E. Fischer, died unexpectedly at her home, the Lawrence Gene

A native of He had resided in this past 32 years. She of Lawrence Chap and was employed Webb company.

Besides her husband, she was survived by a son, Airman First Class E. Fischer Jr., U.S. in Korea; her parents, Margaret (Bayreuth) Germany; two brothers, Albert Hager, both sisters, Mrs. Max many; and several nephews.

The funeral was from the Julius B. funeral chapel, services at 2 p.m. the Rev. Hans Sidtor of Christ Presby Burial was in We etery.

The bearers were Bayreuther, Arthur les M. Brainerd Jr. and George M. and ta.

A delegation chapter, 78, O.E.S. & Webb company neral

MRS. ELIZABETH A. KEY

Mrs. Elizabeth A. Key, a former Andover resident, died Jan. 28 in the home, Newburyport illness.

A native of Sauada, she had resided in Andover for the past 1919 to 1931 she was manager of the Laundry.

Surviving is a son, William B. Brown, Cal., and a granddaughter.

The funeral was from the M. A. funeral home with requiem at 9:30 o'clock at St. Augustine's church.

Burial was in cemetery where Fathered committal services.

The bearers were Burke, Michael Lyr and Raymond Colli

MIRIAM F. DYSON

Miss Miriam F. Dyson, 64, of North Main st., after a long illness, died Jan. 28 in a field, England, by resident of Andover

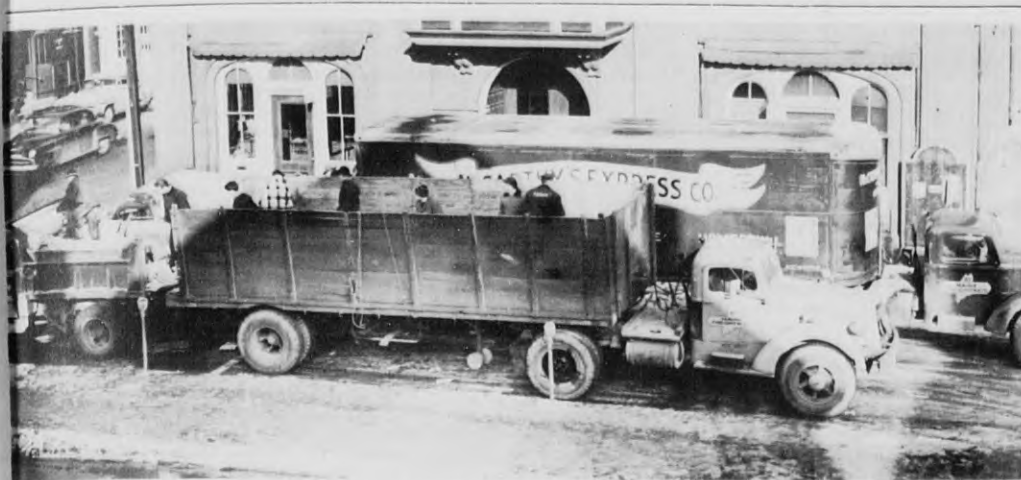

Some of the 12 trucks which were used last Sunday in picking up paper and rags in the drive sponsored by the Andover polio committee in connection with the 1954 March of Dimes campaign. Photo, taken in front of the town house, shows some of the volunteer workers transferring bundles from a smaller truck to a large trailer. (Al Cole Photo)

Polio Paper Drive Sunday A Success

The paper drive held last Sunday in connection with the annual polio campaign was a huge success. According to Co-chairmen James Deyermund and Ray LaRosa over 52,000 pounds of paper were collected by the many volunteers. The chairmen are grateful to the

people of Andover for making this drive so successful and also want to thank the people who volunteered their time and their trucks for this project. During the afternoon coffee, milk and doughnuts were served the workers by the Andover Firemen's auxiliary.

OBITUARIES

MRS. ALBERT E. FISCHER
Mrs. Augusta J. (Hager) Fischer, wife of Albert E. Fischer 8 Yale rd., died unexpectedly Jan. 28 in the Lawrence General hospital.

A native of Hof, Bavaria, she had resided in this country for the past 32 years. She was a member of Lawrence Chapter, 78, O.E.S., and was employed by the Cherry & Webb company.

Besides her husband she leaves a son, Airman First Class Albert E. Fischer Jr., U.S.A.F., stationed in Korea; her parents George and Margaret (Bayreuther) Hager of Germany; two brothers, Hans and Albert Hager, both of Germany; a sister, Mrs. Max Flugel of Germany; and several nieces and nephews.

The funeral was held Sunday from the Julius B. Emmert & Sons funeral chapel, Lawrence, with services at 2 p.m. conducted by the Rev. Hans Sidon, Ph.D., pastor of Christ Presbyterian church. Burial was in West Parish cemetery.

The bearers were: George W. Bayreuther, Arthur J. Vogel, Charles M. Brainerd Jr., Walter A. Fone and George M. and Henry A. Puchta.

A delegation from Lawrence chapter, 78, O.E.S., and the Cherry & Webb company attended the funeral.

MRS. ELIZABETH A. LASKEY
Mrs. Elizabeth Ann (Deagle) Laskey, a former Andover resident, died Jan. 28 in the Jackman Rest home, Newburyport, after a short illness.

A native of Sauris, P. I., Canada, she had resided in Newburyport for the past two years. From 1919 to 1931 she was employed as manager of the Andover Steam Laundry.

Surviving is a daughter, Mrs. William B. Brown of Long Beach, Cal., and a granddaughter.

The funeral was held Saturday from the M. A. Burke Memorial funeral home with a high Mass of requiem at 9:30 o'clock in St. Augustine's church.

Burial was in St. Augustine's cemetery where Fr. Smith conducted committal services.

The bearers were: William Burke, Michael Lynch, Alfred Robb and Raymond Collins.

MIRIAM F. DYSON
Miss Miriam F. Dyson, formerly of North Main st., died Jan. 29 after a long illness at the age of 64. She was a native of Hutterfield, England, but had been a resident of Andover most of her

life. Miss Dyson was a member of the Free Congregational church.

She leaves a brother-in-law, William H. Black, a nephew, Alexander W. D. Black and a niece, Mrs. Gordon T. Richardson all of Beverly and one other niece Mrs. Ralph Stott of England.

Private funeral services were held Sunday in the Lee and Moody funeral home, Beverly.

MRS. EVERETT R. MOUNTAIN
Mrs. Ethel (Lovejoy) Mountain of Milton Mills, N.H., wife of Everett R. Mountain, a native of Andover, died Jan. 26. On Nov. 28, Mr. and Mrs. Mountain celebrated their 50th wedding anniversary.

Surviving besides her husband are five daughters, Mrs. Rudolph M. Andolschek of Jamaica, N.Y., Mrs. Anthony F. Anderson of West Tewksbury; Mrs. L. Alford Frost of Beverly; Mrs. Roy H. Johnson of Pembroke, N.H., and Mrs. Ivar R. Hakanson of Winchester, N.H., and 10 grandchildren.

The funeral was held Saturday from the Mountain funeral home, Lowell.

MRS. MARGARET C. JONES
Mrs. Margaret C. (Atwater) Jones, widow of Gilbert N. Jones, M.D., 119 Shawsheen rd., died Saturday in the Lawrence General hospital after a short illness.

A native of Westfield she resided in Wellesley before coming to Andover 10 years ago.

She leaves a daughter, Mrs. Margaret J. Little, with whom she resided; three grandchildren, John D. C. Little and Frances Ann Little, both of Andover, and Mrs. John R. Dice of Grosse Pointe Woods, Mich., and three great-grandchildren.

The funeral was held from the Lundgren funeral home Tuesday with services at 2 p.m., conducted by the Rev. John S. Moses, rector of Christ Episcopal church. Burial will take place in the spring in Stockbridge cemetery.

VALERE DEMUYSERE
Valere Demuyseere of East Hartford, Conn., a former Andover resident, died unexpectedly Sunday in East Hartford. He was a former employee of the Shawsheen Mills and had been residing in East Hartford for the past three months.

Surviving are his widow, Marie (Demere) Demuyseere; one son, Joseph of Andover; a brother, Alexander in Belgium; and two sisters, Mrs. Palmer Colman of New Haven, Conn., and Mrs. Desire Metzmaker of Andover.

The funeral was held today from the Arthur J. Scott funeral home, Lawrence, with a solemn high Mass of requiem at 9 a.m. in Sacred Heart church. Burial was in Sacred Heart cemetery.

Births...

BRUNDZINSKI - A daughter, Jan. 29 in the Bon Secours hospital to Mr. and Mrs. Alexander Brundzinski (Margaret Gravel) of 78 North st.

GUM - A son, Stephen William, Jan. 14 to Mr. and Mrs. William B. Gum of Charlestown, West Va. The mother is the former Constance McCollum of Lincoln st.

LEE - A son, Charles Edward, Jan. 30 in the Lawrence General hospital to Mr. and Mrs. James C. Lee Jr. (Shirley Bushway) of Holt rd.

ST. JEAN - A daughter, Jan. 27 in the Lawrence General hospital to Mr. and Mrs. George St. Jean (Edith Valentine) 53 Red Spring rd.

OSTEOPATHIC SOCIETY HONORS DR. SANDBERG
Dr. A. Warren Sandberg, 27 Chestnut st., was elected vice president of the Massachusetts Osteopathic Society during the 51st annual convention of the organization recently held in Boston.

INVENTORY FILED
An inventory of the following estate was filed at the registry of probate in Salem last week:
Norman K. MacLeish of Andover; \$2,019.11, personal; no real.

How Christian Science Heals
"OVERCOMING CONTAGION"
WBZ, Sunday, Feb. 7, 9:30 a.m.



1953 MODEL
DISHWASHER-SINK COMBINATION

The G-E Electric Sink combines the General Electric Automatic Dishwasher with a modern cabinet sink, and provides for the installation of the General Electric Disposall. The combination of these appliances will reduce your work and enhance your enjoyment of home-making.

WAS \$450
NOW
\$354²⁰

W. R. HILL 45 MAIN STREET
Tel. 102

SAVE ON FINANCING

Automobiles

Name your OWN TERMS - within reason.

WE offer the most liberal LOW COST BANK FINANCING PLANS in New England.

Loans arranged quickly by telephone. - Call us - let us finance your next car

ANDOVER NATIONAL BANK

TELEPHONE: ANDOVER 1773 - 1161

age
Roads
complaints,
prohorously
throw garbage
private prop-
n.
is involved in
in the offen-
se suspended
in the fine that
olation.
"whoever, in
e, bottles, in
ghway or with-
r upon private
mission, com-
e, shall be
not more than
ele is used in
ance a con-
section shall
by the court to
vehicles, and
spend the li-
of such vehi-
30 days, and
he records of
vehicles that
victed is the
hicle so used,
pend the cer-
tion of said

LE
of The King's
Monday, Feb.
ness session,
to bring gifts

disposition of
ations and free

report of the

any other bus-
ly come before

ed Flats

Later

E
ITE

ULITE

Aid

t promotes
of strong,
igs for the
... the
the farmer.

PING OFF
ERMINATION
GROWTH

tool Pack-
the larger
arm sizes.

RIES DAILY
ANN'S
RE-PAINT

Tel. 4105
Parking Space

Inn
nn"
r 6 to 7:30

TS
BANQUETS
er, Mass.

WEDDING INTENTIONS

The following wedding intentions have been filed at the office of Town Clerk George H. Winslow:

Lucien A. Archambault, 801 Broadway, Haverhill, and Joan I. Davis, 21 Kenilworth st.

Joseph A. Paladino, 3 Marwood drive and Lorraine C. Furlong, 23 Dewey st., Watertown.

Francis X. Higgins, 15 Coolidge st., Lawrence, and Suzanne A. Morin, 172 Summer st.

Charles J. Leary, 18 Hidden rd. and Alice M. Fleming, 16 Lockway rd.

Gilles H. Gosselin, 425 So. Broadway, Lawrence, and Anne M. McCarthy, 44 Magnolia ave.

MARRIAGE RETURN

The following marriage return has been filed at the office of Town Clerk George H. Winslow:

Andrew H. Carbone, 160 Laurel Hill, Torrington, Conn., and Elizabeth A. Ruggiero, Argilla rd., married Jan. 30, at 28 Monroe st., Amesbury, by Justice of the Peace Nimrod E. Olssen.

TRY A TOWNSMAN
WANT AD - CALL 1943

**Sportsman's Club
To Meet Tuesday**

The Andover Sportsman's club will hold a regular business meeting at 8 p.m., Tuesday, Feb. 9 at the club house.

Chester Harnden, chairman of the ways and means committee, requests that all reservations for the annual supper to be held Saturday, Feb. 13 be completed at this meeting. The supper is open to members and guests. This includes ladies, who will be admitted for the first time.

**TAXPAYERS' ASSN.
FAVORS MERGER**

(Continued from Page One)

"Our further studies have convinced us that our tree department which plays a very important part in the beauty and economy of our town can be carried on more efficiently if merged with the public works department.

"Members of this department who so ably care for our trees and parks should be retained in the capacities in which they are most capable. . . They would also have use of the more extensive equipment of the public works department without duplication of units if this merger were to be authorized by the voters."

**WILL CANVASS TOWN
FOR HEART FUND**

(Continued from Page One)

They know as volunteer helpers how the money contributed by this community of Andover will be used to carry on this work that is so vital to the lives and well being of all. They know that 60% of the funds raised through the people of Andover will remain here, where the benefits are available to all through hospitals, doctors and other services.

Twenty-five percent of the fund is forwarded to the American Heart association for scientific research that must be done on a national scale; and 15% remains with the Massachusetts Heart association to be used on a statewide basis.

The Andover committee hopes that these solicitors will be received in the same spirit of friendly willingness to help others that has prompted them to offer their services.

REALTY TRANSFERS

Frank A. Cunningham et al to Paul C. Gibbons et ux, Shawsheen rd.

Dennis J. Hickey to James V. Letters et ux, Tewksbury st.

Joanna C. Downing Foster et alii to Selwyn N. Blake et alii, Summer st.

Elizabeth D. Sargent, Est. to Selwyn N. Blake et alii, Summer st. Joanna C. Downing Foster et alii to Richard E. Merrill, Summer st.

Elizabeth D. Sargent, Est. to Richard E. Merrill, Summer St.

Charles J. Lundergan et ux to Inhabitants of Town of Andover, High st.

Erma Lary Hill to Leslie N. Hutchinson et ux, Salem st. and Woodland rd.

Nelson J. Morin et ux to Blanche M. Skiba, North st.

Alfena Picard to Kenneth Hird et ux, off Corbett rd.

Lathrop B. Merrick et ux to Wolfgang Berthold et ux, Shawsheen rd.

REAL ESTATE**Fred E. Cheever****REAL ESTATE**

21 MAIN STREET

TELS. 775 & 1098

W. SHIRLEY BARNARD**Real Estate and Insurance**

at
Main and Barnard Streets
Telephone 202

K. C. KILLORIN**REALTOR**

77 Main St. Andover

TEL. 2272

TOWNSMAN BUSINESS DIRECTORY**AUTO REPAIRS****CLARK MOTOR
CO.**

AUTHORIZED
CHRYSLER - PLYMOUTH
SALES and SERVICE.
PAINTING and BODY WORK
IN OUR OWN SHOP.

41 PARK ST., ANDOVER
Tel. Andover 333

**PARK
ST.
GARAGE**

33 PARK ST.

GENERAL
AUTO
REPAIRING
JENNEY
GAS & OILS
TEL. 240

BUILDING MATERIAL

LUMBER - PAINTS
WALLPAPER
HARDWARE
SPORTING GOODS
AMMUNITION - TARGETS

J. E. Pitman Est.

63 PARK ST., ANDOVER
TEL. 664

CESSPOOLS**CESSPOOLS PUMPED OUT**

—ALSO—
Cesspools and Septic Tanks
Installed

CHARLES CORBEIL
TEL. LOWELL 7236

CLEANSERS & DYERS**CLEANSING
PRESSING
TAILORING**

MEN'S AND LADIES'
GARMENTS

CALL 1169
Elander & Swanton
56 MAIN ST.
ANDOVER, MASS.

ADVERTISE YOUR BUSINESS
IN THE TOWNSMAN
CLASSIFIED DIRECTORY
CALL AND. 1943

ELECTRICIANS**Archie A. Gunn****MASTER ELECTRICIAN**

Wiring for
Oil Burners - Light - Power
MOTOR & APPLIANCE
REPAIRS

41 PINE ST. TEL. AND. 920

C. A. HILL & CO**Electrical Contractor****CHARLES A. HILL, JR.**

Call us for every residential, commercial and industrial electrical service.

LIGHTING ENGINEERS

13 Chestnut St. Tel. 1076

DALE E.**WEBSTER****Electrician**

MOTOR & APPLIANCE REPAIRS
* PROMPT SERVICE *

Work Called For and Delivered
31 PINE ST. TEL. AND. 2105

PHOTOGRAPHERS

LOOK
PHOTO
SERVICE



DEVELOPING - PRINTING
CAMERAS & SUPPLIES
PICTURE FRAMING
MUSGROVE BLDG., TEL. 1452

SERVICE STATION

Here To Serve . .
John M. Murray
Gulf
Super Service
COR. MAIN AND
CHESTNUT STREETS

TRAVEL**ANDOVER
TRAVEL BUREAU**

Agency For All Airlines
and Steam Ship Lines
21 MAIN ST. TEL. 775-1098
Fred E. Cheever, Mgr.

JEWELERS**John H.****GRECOE**

Jeweler • Optician

Hearing Aids

48 MAIN ST.

TELEPHONE 830-R

RESTAURANTS

The Coffee Mill
125 MAIN ST. TEL. 886
ANDOVER, MASS.

**CHOICE OF FINE
FOODS AND LIQUORS****LOUIS SCANLON'S**

☆ ON THE ANDOVER LINE ☆

**Come To
SWANSON'S****Snack & Hobby Shop**

"WHERE FRIENDS MEET"

REAL ESTATE**Fred E. Cheever****REAL ESTATE**

21 MAIN STREET

TELS. 775 & 1098

W. SHIRLEY BARNARD**Real Estate and Insurance**

at
Main and Barnard Streets
Telephone 202

K. C. KILLORIN**REALTOR**

77 Main St. Andover

TEL. 2272

**Junior Lg. Group
To Meet In Lowell**

Several local members are expected to attend the meeting of the Andover-Lowell Area of the Junior League of Boston to be held at 8 p.m., Monday, Feb. 8 at the home of Mrs. William E. Sharp, 53 Fairmont st., Lowell.

Among those from Andover expected to attend are: Mrs. J. Healds Farrington, Mrs. L. Glenn Yeaton Jr., Mrs. Emery J. Trotter and the latter's daughter, Mrs. George Aarons.

Personals...

Philip B. Holmes Jr., son of Philip B. Holmes, 10 North st., has enlisted as private in the 43rd Transportation Troop Battalion with headquarters at Lawrence Army Reserve Training center in Methuen. He is a sergeant at Punchard.

Christian A. Wiessner, 11 Apple tree lane, divisional manager manufacturing in the American Woolen Co. woolen and worsted mills, was recently named to the board of directors of the company. Mr. Wiessner was resident manager of the Wood mills from June 1949 to November, 1953.

Myron H. Muise, 6 Park st., son of Mr. and Mrs. Lewis W. Muise, recently been promoted to the rank of corporal at Camp Meade, Md. where he is stationed with the 115th Transportation company. He was recently transferred from Camp Breckinridge, Ky.

F. Thomas Critchley, 48 Sale st., has been appointed master brewer and production manager of the Harvard Brewing Co., of Lowell.

John A. Bloom, a student at Phillips academy has been appointed to the U.S. naval academy at Annapolis for admission in June. He is the son of Mr. and Mrs. Max Bloom of Methuen.

James P. Holihan, 60 Bartlett st., president of the Diana Spring brewery, was re-elected director of the U.S. Brewers Foundation at the 76th annual convention last week in Los Angeles, Cal.

**Inter-Church
Basketball**

Results of the games played Monday night in the Interchurch Basketball League are as follows:

Juniors

| | | |
|----------|-----|-----------|
| St. Aug. | 14, | W. Parish |
| Free | 3, | St. Jos. |
| B'Vale | 26, | Baptist |
| Christ | 12, | South |

Intermediates

| | | |
|----------|-----|-----------|
| CYO | 16, | W. Parish |
| St. Aug. | 43, | St. Jos. |
| South | 2, | Christ |

(forfeit)

Seniors

| | | |
|----------|-----|---------|
| CYO | 52, | Baptist |
| St. Aug. | 33, | B'Vale |

Games Next Week

Juniors - Baptist vs. St. Augustine's; CYO vs. B'Vale; South West Parish; St. Joseph's vs. Christ; St. Joseph's vs. B'Vale.

Intermediates - Baptist vs. Free; St. Joseph's vs. B'Vale.

Seniors - B'Vale vs. CYO; Augustine's vs. Baptist.

The game of the season is scheduled for Feb. 15 in the Intermediate division when the St. church five meets St. Augustine's the former having 6 wins and losses, and the latter 7 wins and losses.

There are three more weeks before the league closes its regular season. This will be followed the round-up Monday, Mar. 1, at the banquet Mar. 15 at which prizes will be awarded.

Commonwea**PROB**

Essex, ss.
To all persons in-
state of FENNI
known as IENN
Andover in said

A petition has
said Court for prob-
strament purport-
of said deceased
of Pensville, in
sey, praying th
execatrix there
surely on her bor

If you desire t
your attorney sh
pearance in said
before ten o'clock
the twenty-third
the return day of

Witness, JOHN
First Judge of sa
ninth day of Jar
thousand nine hut

Commonwealth**PROBA**

Essex, ss.
To all person

trust estate unde
TUS PORTER TH
over in said Coun
benefit of GEORG
SON.

The trustee of
sented to said Co
eighth to eleventh

If you desire to
your attorney sh
appearance in sa
fore ten o'clock in
fifteenth day of
return day of this c

Witness, JOHN
quire, First Judge
nineteenth day of
one thousand nine
four.

JOHN J. CO

Commonwealth**PROBATE**

Essex, ss.
To all persons i

tate of FRIEDRIC
MANN, otherwise
FRIEDRICH KLE
DRICH KLEEMANN
said County, decea

The administrat
annexed of said es
to said Court for
and final account.

If you desire to
your attorney sho
appearance in said
fore ten o'clock in
first day of March
of this citation.

Witness, JOHN
quire, First Judge
twenty-first day of
one thousand nine
four.

JOHN J. CO

From the office of:
Harold M. Siskind,
822 Bay State Build
Lawrence, Massach

Commonwealth o**PROBATE**

Essex, ss.
To all persons in

tate of MARION E.
otherwise known
MARS DEN DYSON
SON late of Andover
ceased.

A petition has
said Court for prob-
strament purporting
of said deceased by
DEN, of Auburn, in
ga and State of Ne
that he or some ot
be appointed admin
annexed of said e
named in said will.

If you desire to o
your attorney sho
pearance in said C
before ten o'clock
the twenty-third day
the return day of this
Witness, JOHN V.

LEGAL NOTICES

Commonwealth of Massachusetts
Docket No. 243607
PROBATE COURT

Essex, ss.
To all persons interested in the estate of JENNIE M. HALL otherwise known as JENNIE MAY HALL late of Andover in said County, deceased.

A petition has been presented to said Court for probate of a certain instrument purporting to be the last will of said deceased by HELENE E. KING, of Fenwick, in the state of New Jersey, praying that she be appointed executrix thereof without giving a surety on her bond.

If you desire to object thereto you or your attorney should file a written appearance in said Court at Newburyport before ten o'clock in the forenoon on the twenty-third day of February 1954, the return day of this citation.

Witness, JOHN V. PHELAN, Esquire, First Judge of said Court, this twentieth day of January in the year one thousand nine hundred and fifty-four.

JOHN J. COSTELLO, Register.
4-11-18

Commonwealth of Massachusetts
No. 195560
PROBATE COURT

Essex, ss.
To all persons interested in the trust estate under the will of AUGUSTUS PORTER THOMPSON late of Andover in said County, deceased for the benefit of GEORGIA ROWLEY THOMPSON.

The trustee of said estate has presented to said Court for allowance its eighth to eleventh accounts inclusive.

If you desire to object thereto you or your attorney should file a written appearance in said Court at Salem before ten o'clock in the forenoon on the fifteenth day of February 1954, the return day of this citation.

Witness, JOHN V. PHELAN, Esquire, First Judge of said Court, this nineteenth day of January in the year one thousand nine hundred and fifty-four.

JOHN J. COSTELLO, Register.
28-4-11

Commonwealth of Massachusetts
Docket No. 229,745
PROBATE COURT

Essex, ss.
To all persons interested in the estate of FRIEDRICH JOHANN KLEEMANN, otherwise known as JOHANN FRIEDRICH KLEEMANN and FRIEDRICH KLEEMANN late of Andover in said County, deceased.

The administrator with the will annexed of said estate has presented to said Court for allowance his first and final account.

If you desire to object thereto you or your attorney should file a written appearance in said Court at Salem before ten o'clock in the forenoon on the first day of March 1954, the return day of this citation.

Witness, JOHN V. PHELAN, Esquire, First Judge of said Court, this twenty-first day of January in the year one thousand nine hundred and fifty-four.

JOHN J. COSTELLO, Register.

From the office of:
Harold M. Siskind, Esquire
822 Bay State Building
Lawrence, Massachusetts. 28-4-11

Commonwealth of Massachusetts
No. 243435
PROBATE COURT

Essex, ss.
To all persons interested in the estate of MARION E. MARSDEN DYSON, otherwise known as MARION EDITH MARSDEN DYSON and MARION M. DYSON late of Andover in said County deceased.

A petition has been presented to said Court for probate of a certain instrument purporting to be the last will of said deceased by GEORGE R. MARSDEN, of Auburn, in the County of Cayuga and State of New York and praying that he or some other suitable person be appointed administrator with the will annexed of said estate the executors named in said will having deceased.

If you desire to object thereto you or your attorney should file a written appearance in said Court at Newburyport before ten o'clock in the forenoon on the twenty-third day of February 1954, the return day of this citation.

Witness, JOHN V. PHELAN, Esquire,

First Judge of said Court, this thirtieth day of January in the year one thousand nine hundred and fifty-four.

JOHN J. COSTELLO, Register.
William C. Ford, Attorney
301 Essex Street
Lawrence, Massachusetts 21-28-4

Commonwealth of Massachusetts
No. 143545
PROBATE COURT

Essex, ss.
To all persons interested in the trust estate under the will of WILLIAM M. WOOD, Junior late of Andover in said County, deceased, for the benefit of EDITH R. WOOD (now PORTER) and others.

The trustee of said estate has presented to said Court for allowance its nineteenth to twenty-first accounts inclusive.

If you desire to object thereto you or your attorney should file a written appearance in said Court at Lawrence before ten o'clock in the forenoon on the eighth day of February 1954, the return day of this citation.

Witness, JOHN V. PHELAN, Esquire,

First Judge of said Court, this twelfth day of January in the year one thousand nine hundred and fifty-four.

JOHN J. COSTELLO, Register.
21-28-4

Commonwealth of Massachusetts
No. 228,671
PROBATE COURT

Essex, ss.
To all persons interested in the trust estate under the will of FOSTER C. BARNARD late of Andover in said County, deceased, for the benefit of ELIZABETH D. BARNARD and others.

The trustees of said estate have presented to said Court for allowance their first to third accounts inclusive.

If you desire to object thereto you or your attorney should file a written appearance in said Court at Lawrence before ten o'clock in the forenoon on the eighth day of February 1954, the return day of this citation.

Witness, JOHN V. PHELAN, Esquire, First Judge of said Court, this sixth day of January in the year one thousand nine hundred and fifty-four.

JOHN J. COSTELLO, Register.

Tomlinson & Hatch
301 Essex Street
Lawrence, Mass. 21/28/4

Commonwealth of Massachusetts
Docket No. 241,854
PROBATE COURT

Essex, ss.
To RITA A. GRIGAS of unknown residence.

A petition as amended has been presented to said Court by your husband of Andover, in said County representing that you have deserted him, and that he is living apart from you for justifiable cause, and praying that the Court will, - by its order, prohibit you from imposing any restraint on his personal liberty, and - make such order as it deems expedient concerning the support, and the care, custody and maintenance of your minor child.

If you desire to object thereto you or your attorney should file a written appearance in said Court at Lawrence before ten o'clock in the forenoon on the eighth day of February 1954, the return day of this citation.

Witness, JOHN V. PHELAN, Esquire, First Judge of said Court, this eighteenth day of January in the year one thousand nine hundred and fifty-four.

JOHN J. COSTELLO, Register.

From the Office of:
Atty. Thomas J. Lane
705 Cregg Bldg.,
Lawrence, Mass. 21-28-4

Commonwealth of Massachusetts
Docket No. 243,507
PROBATE COURT

Essex, ss.
To all persons interested in the estate of WILLIAM A. BIEDERMANN, otherwise known as WILLIAM BIEDERMANN late of Andover in said County, deceased.

A petition has been presented to said Court for Probate of a certain instrument purporting to be the last will of said deceased by JOHN J. BIEDERMANN, (named in said will as JOHN BIEDERMANN) of Feabody in said County, praying that he be



"Wow! I've hooked a big one!"

appointed executor thereof without giving a surety on his bond.

If you desire to object thereto you or your attorney should file a written appearance in said Court at Lawrence before ten o'clock in the forenoon on the eighth day of February 1954, the return day of this citation.

Witness, JOHN V. PHELAN, Esquire, First Judge of said Court, this eighteenth day of January in the year one thousand nine hundred and fifty-four.

JOHN J. COSTELLO, Register.

From the office of
Anna M. Greeley
Counselor-at-Law
21 Main St.
Andover, Mass. 21-28-4

Commonwealth of Massachusetts
Docket No. 243,555
PROBATE COURT

Essex, ss.
To all persons interested in the estate of IDA E. HOFMANN, otherwise known as IDA C. HOFMANN and IDA CROUSE HOFMANN late of Andover in said County, deceased.

A petition has been presented to said Court for probate of a certain instrument purporting to be the last will of said deceased by CHARLES H. MURNANE of Andover in said County, praying that he be appointed executor thereof without giving a surety on his bond.

If you desire to object thereto you or your attorney should file a written appearance in said Court at Newburyport before ten o'clock in the forenoon on the twenty-third day of February 1954, the return day of this citation.

Witness, JOHN V. PHELAN, Esquire, First Judge of said Court, this twenty-fifth day of January in the year one thousand nine hundred and fifty-four.

JOHN J. COSTELLO, Register.

From the office of
Anna M. Greeley
Counselor-at-Law
21 Main Street
Andover, Massachusetts 28-4-11

Commonwealth of Massachusetts
No. 243,564
PROBATE COURT

Essex, ss.
To all persons interested in the estate of ANDREW J. CASEY late of Andover in said County, deceased.

A petition has been presented to said Court, praying that MARGARET C. COMISKEY of Needham in the County of Norfolk or some other suitable person be appointed administrator of said estate.

If you desire to object thereto you or your attorney should file a written appearance in said Court at Newburyport before ten o'clock in the forenoon on the twenty-third day of February 1954, the return day of this citation.

Witness, JOHN V. PHELAN, Esquire, First Judge of said Court, this twenty-fifth day of January in the year one thousand nine hundred and fifty-four.

JOHN J. COSTELLO, Register.

From the Office of:
Atty. Thomas J. Lane
705 Cregg Bldg.,
Lawrence, Mass. 21-28-4

Commonwealth of Massachusetts
Docket No. 243,507
PROBATE COURT

Essex, ss.
To all persons interested in the estate of WILLIAM A. BIEDERMANN, otherwise known as WILLIAM BIEDERMANN late of Andover in said County, deceased.

A petition has been presented to said Court for Probate of a certain instrument purporting to be the last will of said deceased by JOHN J. BIEDERMANN, (named in said will as JOHN BIEDERMANN) of Feabody in said County, praying that he be

After spending the holidays at

CLASSIFIED ADS

Personal

COINS WANTED - Top prices paid for collections of old United States coins. Call Melrose 4-3917 or write Arthur Conn, Melrose, Mass. A-TF

SPANISH-SPEAKING ARGENTINE woman, employed in Andover household seeks companionship of Spanish-speaking woman, possibly native of South America. Call Andover 1003. A-4-11

Lost and Found

ANDOVER NATIONAL Bank Pass book No. 6447 has been lost and application made for payment in accordance with Sec. 20, Chap. 167 of the General Laws. Payment has been stopped. B-4-11-18

ANDOVER NATIONAL Bank Pass book No. 11140 has been lost and application made for payment in accordance with Sec. 20, Chap. 167 of the General Laws. Payment has been stopped. B-4-11-18

Services Offered

GENERAL WORK, Landscaping; Cellars and Attics Cleaned. Grade A Loam, Sand, Filling and Stones. Garbage removed. Romano Trucking. Tel. And. 946-J. C-TF

ALTERATIONS AND Dressmaking skillfully done. Quick dependable service. Mrs. Alice Hewett, 35 Washington Ave., Tel. 635-R. C-TF

CLOCKS REPAIRED, old and new, called for and delivered too. Harold Dennison, 83 High St., Andover. Tel. And. 2222-M. C-TF

DRESSMAKING and Alterations. Specializing in children's clothing. Mrs. C. A. Piquette, 6A Burnham Rd., Tel. Andover 2255-M. C-TF

TRASH, GARBAGE & Disposal. Trash 30¢ per barrel. Garbage 25¢ per week. Cellars, yards, stores and factories cleaned. Any refuse removed. Frank J. McLaughlin, Ballardvale St., North Wilmington. Tel. Oliver 8-2371. C-TF

Help Wanted—Male

UNUSUAL OPPORTUNITY offers \$30 to \$50 weekly spare time - \$100 or more full time. Man appointed now can work into district supervisor position paying \$11,000 per year and up. Product well advertised and accepted liquid fertilizer backed by written guarantee. Little traveling - home nights - but car is essential. Write to: "Na-Churs", 210W Monroe Street, Marion, Ohio. I-28-4-11

home he left for Bristol, Tenn., where he will be engaged for the next year in directing a million dollar campaign for King college,

according to Dr. Arnaud C. Marts, president of the firm.

Dr. Marts was recently asked to assist the New York legislative committee on charitable and philanthropic agencies in the investigation of charity racketeering.

DAY and NIGHT

ANDOVER TAXI SERVICE

... CALL 414 ...
POST OFFICE AVENUE

Articles for Sale

WINCHESTER - OLDER Model 52 target rifle. Lyman globe front sight, battle rear. Telescopic mounts. Sling. If interested please write Box C-25, Andover Townsman, Andover, Mass. O-4-11

FOR SALE - LADIES Mouton Lamb fur coat. Size 12-14. Like new. Original cost \$200. sell for \$65. Call Andover 366 or call at 9 Virginia rd. O-4

Wanted to Buy

ANTIQUES - BRENNAN buys fancy china, Old English, French, German dishes, glassware, vases, figurines, dolls, marble tops, walnut, grape and rose chairs, silver, furniture. Call or write John J. Brennan, 11 Rosewood Rd., Methuen. Tel. Lawrence 4684 or 38004. Appraisals cheerfully given. TF

ANTIQUES OR ANYTHING old. Marble-top. Walnut. Grape and Rose-carved Furniture, Glass, China, Silver, Jewelry, Clocks, Prints, Frames, Guns, Coins, Furniture Etc., William F. Graham Jr., 165 Golden Hill Ave., Haverhill, Mass. Telephone Haverhill 23708. Will call to look. TF

WANTED TO BUY - Old dolls, jewelry, buttons, china, clocks, glassware, furniture, coins, and stamps. Anything good and usable. Estimates and appraisals. Call North Reading 4-4063. Write Box 113, North Reading. TF

PHILLIPS ACADEMY GRADUATE buying picture frames, old desks, jewelry, dishes, dolls, and marble top furniture. Appraisals given in strictest confidence. Tel. Lawrence 83072. TF

For Rent—Apts and Flats

LOCKE ST. - FURNISHED room for rent. Gentleman preferred. Tel. Andover 274-R or apply 4 Locke St. V-TF

Auto School

OPEN YEAR ROUND. Bloom Auto Driving School. 24 years in business. Guarantees to teach you. Secured licenses for thousands. Pick up service available. Dual Safety Control cars. Tel. Lawrence 25946. TF

ELECTED DIRECTOR

Ernest E. Anderson of Ballardvale rd., was elected a director for three years at the annual meeting of the Essex County Co-operative Farming association held at Topsfield yesterday.

Call Us...



Automatic Heating HEADQUARTERS in Greater Lawrence
SALES & SERVICE
24 HOUR SERVICE
FREE HOME HEATING SURVEYS

CYR OIL COMPANY
100 WATER ST. LAWRENCE
TEL. 32775

g. Group In Lowell
... members are ...
... Feb. 8 at the ...
... E. Sharp, 53 ...
... from Andover ...
... are: Mrs. J. ...
... Mrs. L. Gley ...
... s. Emery J. Trot ...
... daughter, Mrs. Gea ...
nals...
... Jones Jr., son of ...
... Phillip B. Holmes, ...
... s enlisted as priv ...
... Transportation fr ...
... headquarters at ...
... my Reserve Traini ...
... huen. He is a sen ...
... Wiessner, II App ...
... divisional manag ...
... g in the Americ ...
... woolen and worst ...
... recently named to ...
... ctors of the compan ...
... was resident manag ...
... mills from June 19 ...
... 1953.
... luise, 6 Park st., ...
... s. Lewis W. Muise ...
... n promoted to the r ...
... at Camp Meade, ...
... s stationed with t ...
... portation company ...
... transferred from Ca ...
... Ky.
... s Critchley, 48 Sal ...
... n appointed man ...
... production manag ...
... Brewing Co., of L ...
... room, a student at ...
... has been appoint ...
... naval academy at ...
... mission in June. He ...
... r, and Mrs. Max Blo ...
... Holihan, 60 Bart ...
... nt of the Dian ...
... ry, was re-elected ...
... e U.S. Brewers Fou ...
... 76th annual conv ...
... t in Los Angeles, C ...
Church tball
... the games play ...
... in the Interch ...
... ague are as follows ...
14, W. Parish
3, St. Jos.
26, Baptist
12, South
16, W. Parish
13, St. Jos.
2, Christ
(forfeit)
32, Baptist
13, B'Vale
Week
... baptist vs. St. Aug ...
... s. B'Vale; South ...
... t. Joseph's vs. Chr ...
... s - Baptist vs. B' ...
... B'Vale.
... B'Vale vs. C.Y.O ...
... Baptist
... the season is se ...
... 15 in the Inter ...
... ets St. Augustin ...
... ving 6 wins an ...
... latter 7 wins an ...
... ee more weeks to ...
... ue closes its reg ...
... will be followe ...
... Monday, Mar. 1 ...
... r. 15 at which ...
... warded.

Elects Collier Baseball Coach

Robert Collier was elected varsity baseball coach at Pynchard by a vote of the school committee Tuesday night at a salary of \$400. He has been coach of the JV baseball and basketball teams. Collier succeeds Richard Preston who has left the local school faculty.

The election was made on a motion of Sec. William A. Doherty seconded by Mrs. Dorothy Partridge.

On another motion by Mr. Doherty seconded by Mrs. Partridge the board authorized the sending of a boy and a coach — John Cole and Bob McIntyre — to the national interscholastic track meet in New York Feb. 20 and to the Bowdoin interscholastic championship meet at Brunswick, Me., in March. Cole, an outstanding shot putter will try for new records at these meets.

All members were present with Gordon L. Colquhoun, chairman, presiding.

On motion of Charles C. Kimball seconded by Miss Anna M. Greeley the board approved the warrant of bills and accounts in the amount of \$6174.48.

On motion of Mrs. Partridge seconded by Mr. Kimball the board approved the P.H.S. Athletic association warrant in the amount of \$658.49 and on motion of Miss Greeley seconded by Mrs. Partridge approved an athletic warrant of \$1458.

A letter from the Perley Gilbert Associates of Lowell asking for consideration as architects in any new building construction was referred to the school building committee.

On motion of Miss Greeley seconded by Mrs. Partridge the Shawsheen cub scouts were granted use of the Shawsheen school on Saturday mornings.

On motion of Mrs. Partridge seconded by Mr. Doherty the board authorized the superintendent to purchase 50 reading circle chairs at \$5.10 each, six 15-in. chairs at \$5.10 each, and ten 16-in. chairs at \$7.15 each from the Milton Bradley Co., the lowest of several bidders.

Supt. Erickson advised the board of the need of an additional steam table for the cafeteria in the Cen-

tral elementary school.

It was voted to hold the next meeting Tuesday, Mar. 16, the change being due to the annual town meeting Mar. 8.

On motion of Mr. Doherty seconded by Mrs. Partridge the board adjourned at 8:58 p.m., establishing a record for recent years for the brevity of the session.

"POP" WILSON NEARS 83RD BIRTHDAY

(Continued from Page One)

The double birthday anniversaries this month find both in good health and both still engaged in routine activities. "Pop" is be-

hind the counter at the store on Main street every day where he has been for the past 25 years since he came here from Amesbury. Mrs. Wilson still performs her daily household duties and takes active interests in affairs of the town.

"Pop" says he appreciates very much the patronage given him by townspeople since he has been here and is grateful to his son, P. LeRoy Wilson who with Mrs. Lewis W. Muise assist him in his business.

He is in good health and enjoys meeting his friends as he goes about his duties every day.

\$3696 Collected In Mothers' March

The annual Mothers' March on Polio last Thursday night was most successful as the 256 women who braved the freezing weather reported \$3696.50 collected in their canvass.

A year ago the mothers set the high mark of \$3373.39 in their house to house campaign for funds to fight polio, but last Thursday's effort surpassed this figure.

J. Woodrow Crowley, who was co-chairman for Andover with Fire Chief C. Edward Buchan, reports that the 1954 sum may yet be in-

creased as there are a few more sources to hear from.

In the entire campaign during the month of January several activities were undertaken to raise funds for this drive and a report on the entire amount collected in the town will be made later.

Subscribe to the TOWNSMAN

PAUL'S 127 MAIN ST. TEL. 2125
25 Years' Experience
Dressmaking Remodeling
Alterations
Ladies' Suits, Coats and Dresses
Made to Order

The most modern SIX

The new 115-h.p. I-block Six is the only completely modern six-cylinder engine in the industry . . . the only low-priced Six with all these features!

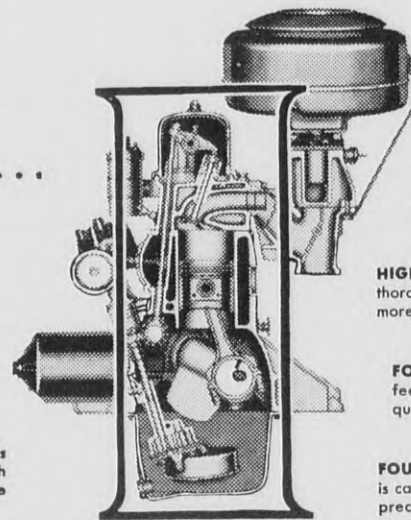

DEEP-CAST I-BLOCK with skirt that extends below the crankshaft, provides the great strength and rigidity needed for smooth, quiet engine performance and extra long engine life.

FREE-TURNING OVERHEAD VALVES make possible greater high-compression power, longer valve life.

SHORT STROKE, LOW-FRICTION DESIGN gives you more usable horsepower, with less engine wear.

HIGH-TURBULENCE COMBUSTION CHAMBERS thoroughly mix fuel and air for faster, more efficient combustion.

FOUR-PORT INTAKE MANIFOLD feeds fuel fast and uniformly for quick starts and smooth "GO."

FOUR-BEARING CRANKSHAFT is cast rather than forged for more precise balance and smoother operation.

The savingest SIX

No other six in America offers the short-stroke, low-friction economy designed into this new Ford engine!

Ford's new Overhead-Valve I-block Six, with its completely modern high-compression, low-friction design, brings you even better gas economy than last year's Ford Six . . . the Six (with Overdrive) that beat all other cars, regardless of size or price, in the 1953 Mobilgas Economy Run Sweepstakes. And this year's Six also gives you a dividend of 14% more horsepower!

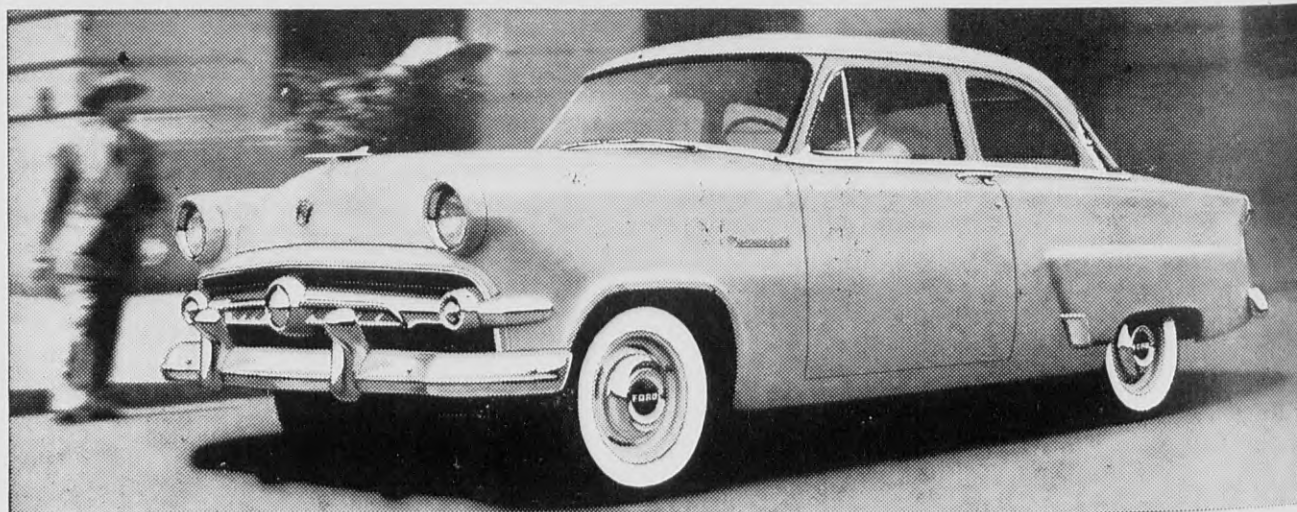

Come in and Test Drive the new 115-h.p.

Ford Overdrive optional at extra cost F.D.A.F.



FORD I-BLOCK SIX
SHAWSHEEN MOTOR MART
47 HAVERHILL ST. ANDOVER, MASSACHUSETTS

P.S. You'll get the savingest used car deal at your Ford Dealer's, too!

FOLKS

As per usual during the month of February we will give

20% Discount

On All Stock

MIRRORS

in our display.

Our full length door mirror size 22x68 inches will be priced as always \$18.50 with 6 clips.

Now is your chance.

Lawrence Plate & Window Glass Co.

417 CANAL ST., Lawrence



Members of the various problems of the town, Charles Simpson, Charles Stack, Paul Whittier, Charles Giovine, and Simeone.

Youth Choirs For Hymn Service

A choir of young people consisting of the eight Protestants of Andover will lead in singing at the University of the Holy Spirit next Sunday evening at the Free church, J. Everett Street. They met twice with this group in the singing of some of the great hymns of the Christian Church.

The service, which will be held at 7:30 p.m. (Continued on Page 17)

Medical Milestones

Today Your Pharmacy Drops a Word About

INSULIN 1922

FREDERICK BANTING

Frederick Banting, Canadian scientist, was born in Alliston, Ontario. Educated at the University of Toronto he was awarded the Nobel prize in medicine in 1923.

Medical science owes a longer life to thousands of people when Dr. Banting isolated insulin in 1921.

DALTON PHARMACY
TEL. 107

YOUR DOCTOR'S KNOWLEDGE IS THE KEY TO HEALTH BRING HIS PRESCRIPTION TO